



Features

- Triple Outputs (Independently Regulated)
- Input Voltage Range: 36V to 75V, 80V Surge
- 1500VDC Isolation
- Dual Logic On/Off Control
- Short-Circuit Protection (All Outputs)
- Fixed Frequency Operation
- Over-Temperature Shutdown
- Under-Voltage Lockout
- Space Saving Package: 1.3 sq. in. PCB Area (suffix N)
- Solderable Copper Case
- Safety Approvals:
 - UL60950
 - CSA 22.2 950
 - VDE EN60950

Description

The PT4820 Excalibur™ power modules are a series of isolated triple-output DC/DC converters that operate from a standard (-48V) central office supply. Rated for up to 35W, these regulators are ideal for powering many mixed logic applications. The triple-output voltage combination allows for a compact multiple-output power supply in a single low-profile DC/DC module.

The available output voltage options include a low-voltage power bus for a DSP or ASIC core, and two additional standard logic supply voltages.

The PT4820 series incorporates many features to simplify system integration. These include a flexible On/Off enable control, an input under-voltage lock-out, and over-temperature protection. All outputs have short-circuit protection and are internally sequenced to meet the power-up and power-down requirements of popular DSP ICs.

The PT4820 series is housed in a space-saving solderable case. The module requires no external heat sink and can occupy as little as 1.3 in² of PCB area.

Ordering Information

- PT4821□ = +3.3/+2.5/+1.5V
- PT4822□ = +3.3/+1.8/+1.5V
- PT4823□ = +3.3/+2.5/+1.2V
- PT4824□ = +3.3/+1.8/+1.2V
- PT4825□ = +3.3/+1.5/+1.2V
- PT4826□ = +5.0/+3.3/+1.8V
- PT4827□ = +3.3/+2.5/+1.8V
- PT4828□ = +5.0/+2.5/+1.5V
- PT4829□ = +5.0/+1.8/+1.5V
- PT4831□ = +5.0/+3.3/+1.5V
- PT4832□ = +5.0/+3.3/+2.5V
- * PT4833□ = +3.3/+2.0/+1.5V

* The PT4833 is not included in the VDE safety certification.

PT Series Suffix (PT1234 x)

Case/Pin Configuration	Order Suffix	Package Code
Vertical	N	(ENM)
Horizontal	A	(ENN)
SMD	C	(ENP)

(Reference the applicable package code drawing for the dimensions and PC layout)

Typical Application

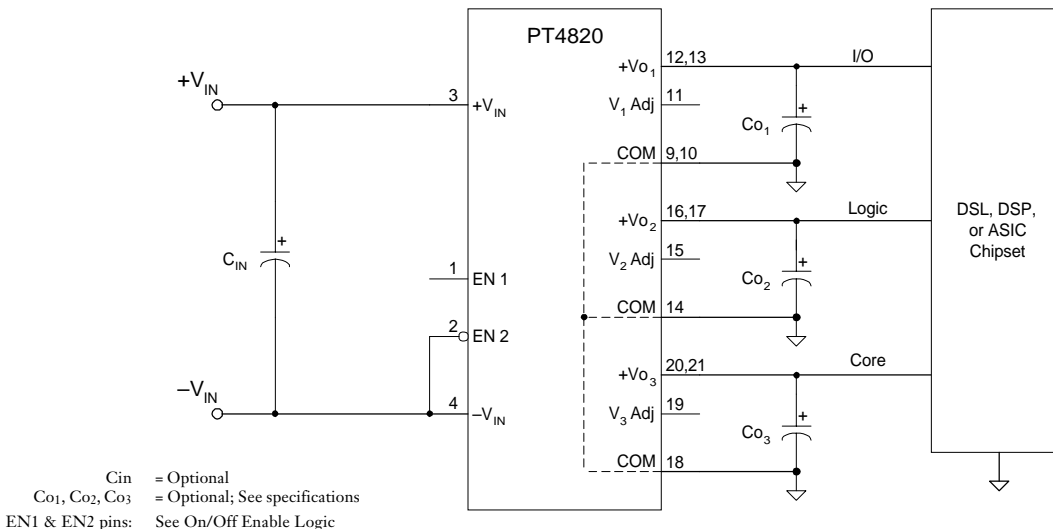

Environmental Specifications

Characteristics	Symbols	Conditions	Min	Typ	Max	Units
Ambient Temperature Range	T _a	Over V _{in} Range	-40	—	+85 (i)	°C
Case Temperature	T _c	Measured at center of case	—	—	+100	°C
Shutdown Temperature	OTP			115	125	°C
Solder Reflow Temperature	T _{reflow}	Surface temperature of module pins or case	—	—	215 (ii)	°C
Storage Temperature	T _s	—	-40	—	+125	°C
Mechanical Shock		Per Mil-STD-883D, Method 2002.3 1 msec, ½ Sine, mounted	—	500	—	G's
Mechanical Vibration		Mil-STD-883D, Method 2007.2 20-2000 Hz	Suffix A, C	20 (iii)	—	G's
Weight	—	Vertical/Horizontal	—	50	—	grams
Flammability	—	Meets UL 94V-O				

Notes: (i) See SOA curves or consult factory for appropriate derating.
 (ii) During solder reflow of SMD package version, do not elevate the module case, pins, or internal component temperatures above a peak of 215°C. For further guidance refer to the application note, "Reflow Soldering Requirements for Plug-in Power Surface Mount Products," (SLTA051).
 (iii) The case pins on through-hole pin configurations (N & A) must be soldered. For more information see the applicable package outline drawing.

Pin Configuration

Pin	Function	Pin	Function
1	EN 1	12	Vo ₁
2	EN 2	13	Vo ₁
3	+Vin	14	COM
4	-Vin	15	Vo ₂ adjust
5	Do Not Connect	16	+Vo ₂
6	Pin Not Present	17	+Vo ₂
7	Pin Not Present	18	COM
8	Pin Not Present	19	Vo ₃ adjust
9	COM	20	+Vo ₃
10	COM	21	+Vo ₃
11	Vo ₁ Adjust		

Note: Shaded functions indicates those pins that are at primary-side potential. All other pins are referenced to the secondary.

On/Off Enable Logic

Pin 1	Pin 2	Output Status
×	1	Off
1	0	On
0	×	Off

Notes:
 Logic 1 = Open collector
 Logic 0 = -Vin (pin 2) potential
 For positive Enable function, connect pin 2 to pin 4 and use pin 1.
 For negative Enable function, leave pin 1 open and use pin 2.
 For automatic power-up connect pin 2 to pin 4 and leave pin 1 open.

Pin Descriptions

+Vin: The positive input supply for the module with respect to -Vin. When powering the module from a -48V telecom central office supply, this input is connected to the primary system ground.

-Vin: The negative input supply for the module, and the 0VDC reference for the EN 1, and EN 2 inputs. When powering the module from a +48V supply, this input is connected to the 48V(Return).

EN 1: The positive logic input that activates the module output. If not used, this pin should be left open circuit. Connecting this input to -Vin disables the module's outputs.

EN 2: The negative logic input that activates the module output. This pin must be connected to -Vin to enable the module's outputs. A high impedance disables the module's outputs.

Vo 1: The highest regulated output voltage, which is referenced to the COM node.

Vo 2: The regulated output that is designed to power logic circuitry. It is referenced to the COM node.

Vo 3: The low-voltage regulated output that provides power for a μ -processor or DSP core, and is referenced to the COM node.

COM: The secondary return reference for the module's three regulated output voltages. It is DC isolated from the input supply pins.

Vo₁ Adjust: Using a single resistor, this pin allows Vo₁ to be adjusted higher or lower than the preset value. If not used, this pin should be left open circuit.

Vo₂ Adjust: Using a single resistor, this pin allows Vo₂ to be adjusted higher or lower than the preset value. If not used, this pin should be left open circuit.

Vo₃ Adjust: Using a single resistor, this pin allows Vo₃ to be adjusted higher or lower than the preset value. If not used, this pin should be left open circuit.

PT4821 Electrical Specifications (Unless otherwise stated, the operating conditions are: $T_a = 25^\circ\text{C}$, $V_{in} = 48\text{V}$, and $I_o = 0.5I_{o,max}$)

Characteristics	Symbols	Conditions	PT4821			Units	
			Min	Typ	Max		
Output Current	I_o	Each output	I_{o1} (3.3V)	0.25 (1)	—	8 (2)	A
			I_{o2} (2.5V)	0.1 (1)	—	6 (2)	
			I_{o3} (1.5V)	0.1 (1)	—	6 (2)	
		Total ($I_{o1} + I_{o2} + I_{o3}$)	—	—	12 (2)	A	
Input Voltage Range	V_{in}	Continuous Surge (1 minute)		36	—	75	V
				—	—	80	
Set-Point Voltage	V_o		V_{o1}	3.24	3.3	3.36	V
			V_{o2}	2.45	2.5	2.55	
			V_{o3}	1.47	1.5	1.53	
Temperature Variation	Reg_{temp}	$-40^\circ\text{C} \leq T_a \leq +85^\circ\text{C}$, $I_o = I_{o,min}$	V_{o1}	—	± 0.5	—	% V_o
			V_{o2}/V_{o3}	—	± 0.5	—	
Line Regulation	Reg_{line}	All outputs, Over V_{in} range		—	± 0.1	± 0.5	% V_o
Load Regulation	Reg_{load}	All outputs, $0 \leq I_o \leq I_{o,max}$		—	± 0.1	± 0.5	% V_o
Total Output Voltage Variation	$\Delta V_o, \text{tol}$	Includes set-point, line, load, $-40^\circ\text{C} \leq T_a \leq +85^\circ\text{C}$	V_{o1}	—	—	± 3 (3)	% V_o
			V_{o2}/V_{o3}	—	—	± 3 (3)	
Efficiency	η	$I_{o1} = 6\text{A}$, $I_{o2} = 2\text{A}$, $I_{o3} = 2\text{A}$		—	87	—	%
V_o Ripple/Noise (0 to 20MHz bandwidth)	V_n		V_{o1}	—	40	—	mV _{pp}
			V_{o2}	—	35	—	
			V_{o3}	—	25	—	
Transient Response	t_{tr} V_{os}	0.1A/ μs load step, 50% to 75% $I_{o,max}$ V_o over/undershoot		—	200	—	μSec % V_o
				—	3	—	
Output Adjust Range	$V_{o,adj}$		$V_{o1}/V_{o2}/V_{o3}$	—	± 10	—	% V_o
Over-Current Threshold	I_{TRIP}	Total, all outputs. Reset with auto-recovery		—	14	—	A
Switching Frequency	f_s	Over V_{in} and I_o ranges		350	400	450	kHz
Under Voltage Lockout	V_{on} V_{off}	V_{in} increasing V_{in} decreasing		—	35.5	—	V
				—	34	—	
Turn-On Time	t_{on}	$V_{in} = 48\text{V}$ step		—	140 (4)	—	ms
Enable Control (pins 1 & 2) High-Level Input Voltage Low-Level Input Voltage Low-Level Input Current	V_{IH} V_{IL} I_{IL}	Referenced to $-V_{in}$ (pin 4)		4	—	15 (5)	V
				-0.2	—	0.8	
				—	1	2	
Standby Input Current	$I_{in, standby}$	pins 1 & 2 open circuit		—	1	5	mA
Internal Input Capacitance	C_{int}			—	1.14	—	μF
External Output Capacitance	C_{O1} C_{O2} C_{O3}			0	220	1,000 (6)	μF
				0	220	1,000 (6)	
				0	220	1,000 (6)	
Primary/Secondary Isolation	V_{iso} C_{iso} R_{iso}			1500	—	—	V pF M Ω
				—	2,200	—	
				10	—	—	

- Notes:** (1) The converter will operate down to no load with reduced specifications.
(2) The sum-total current from outputs V_{o1} , V_{o2} , and V_{o3} not to exceed 12ADC.
(3) Limits are specified by design.
(4) Measured from the application of the input voltage to the instance that all outputs are in regulation.
(5) The Enable inputs (pins 1 & 2) have internal pull-ups. Leaving pin 1 open-circuit and connecting pin 2 to $-V_{in}$ allows the the converter to operate when input power is applied. The maximum open-circuit voltage is 4V.
(6) Ultra-low ESR capacitors, such as organic or polymer aluminum electrolytic types, may cause instability. Consult the factory before using.

PT4821 Performance Characteristics (See Notes A, B)

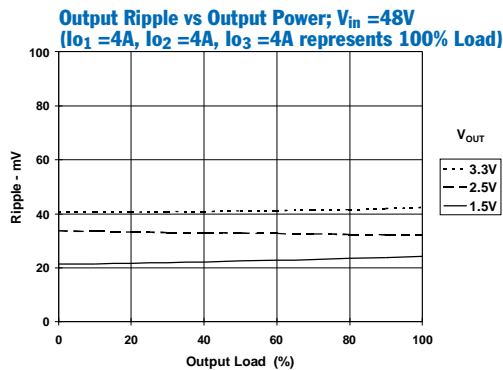
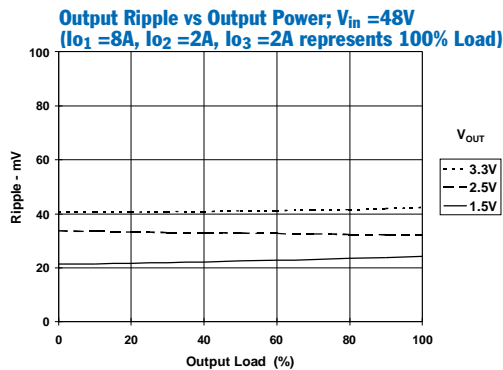
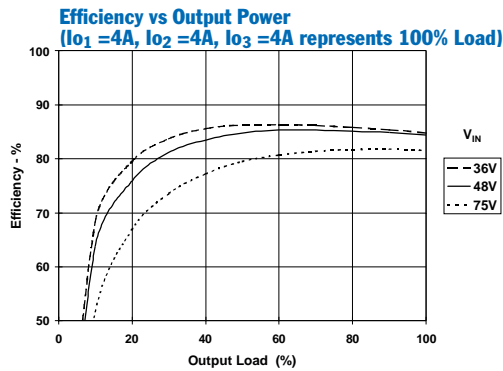
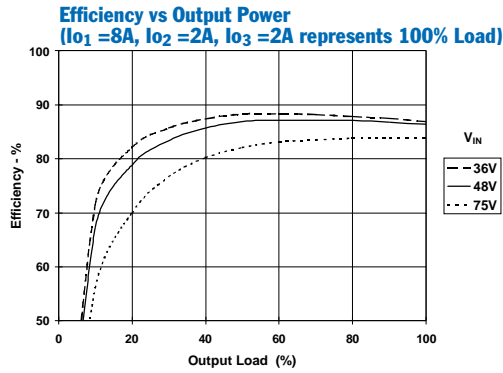

PT4821 Thermal Performance (See Note C)
($I_{o1} + I_{o2} + I_{o3} = 12A$, represents 100% Load)

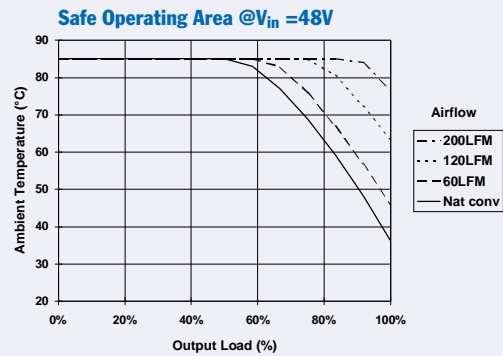
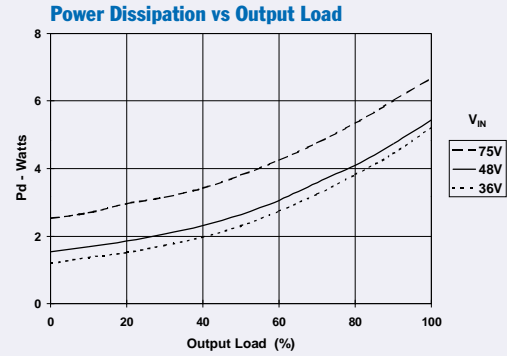

Note A: All Characteristic data in the above graphs has been developed from actual products tested at 25°C. This data is considered typical data for the ISR.

Note B: Output Load (%) represents the percent drawn from each output of the stated 100% load condition.

Note C: SOA curves represent operating conditions at which the internal components are at or below the manufacturer's maximum rated operating temperatures.

PT4822 Electrical Specifications (Unless otherwise stated, the operating conditions are: $T_a = 25^\circ\text{C}$, $V_{in} = 48\text{V}$, and $I_o = 0.5I_{o,max}$)

Characteristics	Symbols	Conditions	PT4822			Units	
			Min	Typ	Max		
Output Current	I_o	Each output	I_{o1} (3.3V)	0.25 (1)	—	8 (2)	A
			I_{o2} (1.8V)	0.1 (1)	—	6 (2)	
			I_{o3} (1.5V)	0.1 (1)	—	6 (2)	
		Total ($I_{o1} + I_{o2} + I_{o3}$)		—	—	12 (2)	A
Input Voltage Range	V_{in}	Continuous		36	—	75	V
			Surge (1 minute)	—	—	80	
Set-Point Voltage	V_o		V_{o1}	3.24	3.3	3.36	V
			V_{o2}	1.76	1.8	1.84	
			V_{o3}	1.47	1.5	1.53	
Temperature Variation	Reg_{temp}	$-40^\circ\text{C} \leq T_a \leq +85^\circ\text{C}$, $I_o = I_{o,min}$	V_{o1}	—	± 0.5	—	% V_o
			V_{o2}/V_{o3}	—	± 0.5	—	
Line Regulation	Reg_{line}	All outputs, Over V_{in} range		—	± 0.1	± 0.5	% V_o
Load Regulation	Reg_{load}	All outputs, $0 \leq I_o \leq I_{o,max}$		—	± 0.1	± 0.5	% V_o
Total Output Voltage Variation	$\Delta V_o, \text{tol}$	Includes set-point, line, load, $-40^\circ\text{C} \leq T_a \leq +85^\circ\text{C}$	V_{o1}	—	—	± 3 (3)	% V_o
			V_{o2}/V_{o3}	—	—	± 3 (3)	
Efficiency	η	$I_{o1} = 6\text{A}$, $I_{o2} = 2\text{A}$, $I_{o3} = 2\text{A}$		—	86	—	%
V_o Ripple/Noise (0 to 20MHz bandwidth)	V_n		V_{o1}	—	40	—	mV _{pp}
			V_{o2}	—	25	—	
			V_{o3}	—	25	—	
Transient Response	t_{tr} V_{os}	0.1A/ μs load step, 50% to 75% $I_{o,max}$ V_o over/undershoot		—	200	—	μSec % V_o
				—	3	—	
Output Adjust Range	$V_{o,adj}$		$V_{o1}/V_{o2}/V_{o3}$	—	± 10	—	% V_o
Over-Current Threshold	I_{TRIP}	Total, all outputs. Reset with auto-recovery		—	14	—	A
Switching Frequency	f_s	Over V_{in} and I_o ranges		350	400	450	kHz
Under Voltage Lockout	V_{on} V_{off}	V_{in} increasing V_{in} decreasing		—	35.5	—	V
				—	34	—	
Turn-On Time	t_{on}	$V_{in} = 48\text{V}$ step		—	140 (4)	—	ms
Enable Control (pins 1 & 2) High-Level Input Voltage Low-Level Input Voltage Low-Level Input Current	V_{IH} V_{IL} I_{IL}	Referenced to $-V_{in}$ (pin 4)		4	—	15 (5)	V
				-0.2	—	0.8	
				—	1	2	
Standby Input Current	$I_{in, standby}$	pins 1 & 2 open circuit		—	1	5	mA
Internal Input Capacitance	C_{int}			—	1.14	—	μF
External Output Capacitance	C_{O1} C_{O2} C_{O3}			0	220	1,000 (6)	μF
				0	220	1,000 (6)	
				0	220	1,000 (6)	
Primary/Secondary Isolation	V_{iso} C_{iso} R_{iso}			1500	—	—	V pF M Ω
				—	2,200	—	
				10	—	—	

Notes: (1) The converter will operate down to no load with reduced specifications.

(2) The sum-total current from outputs V_{o1} , V_{o2} , and V_{o3} cannot exceed 12ADC.

(3) Limits are specified by design.

(4) Measured from the application of the input voltage to the instance that all outputs are in regulation.

(5) The Enable inputs (pins 1 & 2) have internal pull-ups. Leaving pin 1 open-circuit and connecting pin 2 to $-V_{in}$ allows the the converter to operate when input power is applied. The maximum open-circuit voltage is 4V.

(6) Ultra-low ESR capacitors, such as organic or polymer aluminum electrolytic types, may cause instability. Consult the factory before using.

PT4822 Performance Characteristics (See Note A, B)

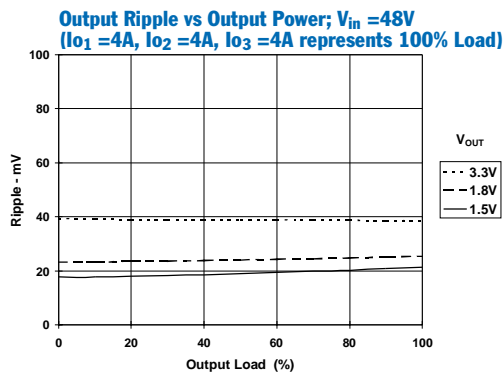
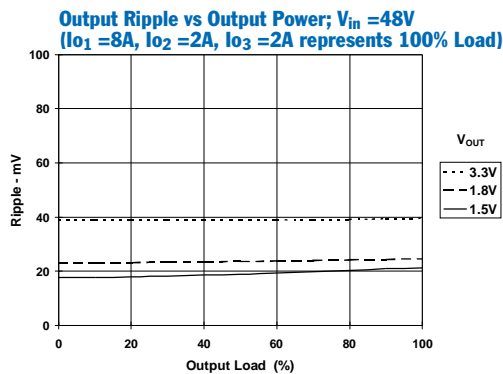
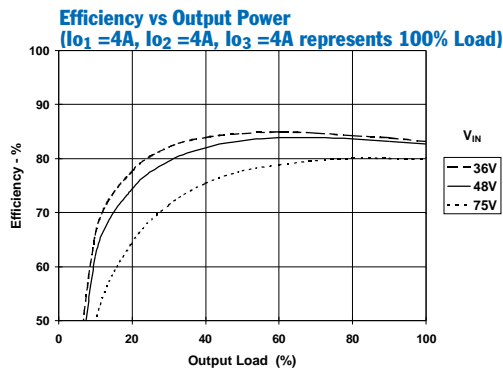
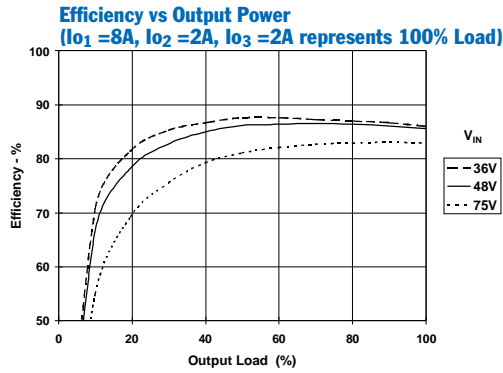

PT4822 Thermal Performance (See Note C)
($I_{o1} + I_{o2} + I_{o3} = 12A$, represents 100% Load)

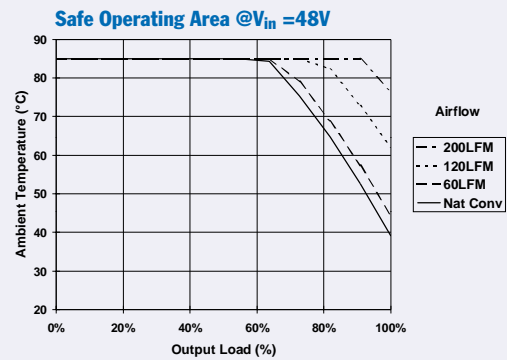
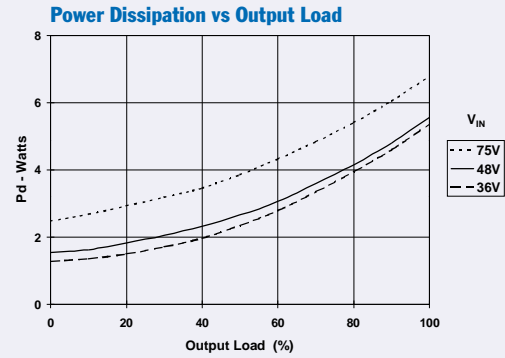

Note A: All Characteristic data in the above graphs has been developed from actual products tested at 25°C. This data is considered typical data for the ISR.
Note B: Output Load (%) represents the percent drawn from each output of the stated 100% load condition.
Note C: SOA curves represent operating conditions at which the internal components are at or below the manufacturer's maximum rated operating temperatures.

PT4823 Electrical Specifications (Unless otherwise stated, the operating conditions are: $T_a = 25^\circ\text{C}$, $V_{in} = 48\text{V}$, and $I_o = 0.5I_{o,max}$)

Characteristics	Symbols	Conditions	PT4823			Units	
			Min	Typ	Max		
Output Current	I_o	Each output	I_{o1} (3.3V) I_{o2} (2.5V) I_{o3} (1.2V)	0.25 (1) 0.1 (1) 0.1 (1)	— — —	8 (2) 6 (2) 6 (2)	A
		Total ($I_{o1} + I_{o2} + I_{o3}$)		—	—	12 (2)	A
Input Voltage Range	V_{in}	Continuous Surge (1 minute)		36 —	— —	75 80	V
Set-Point Voltage	V_o		V_{o1} V_{o2} V_{o3}	3.24 2.45 1.17	3.3 2.5 1.2	3.36 2.55 1.23	V
Temperature Variation	Reg_{temp}	$-40^\circ\text{C} \leq T_a \leq +85^\circ\text{C}$, $I_o = I_{o,min}$	V_{o1} V_{o2}/V_{o3}	— —	± 0.5 ± 0.5	— —	% V_o
Line Regulation	Reg_{line}	All outputs, Over V_{in} range		—	± 0.1	± 0.5	% V_o
Load Regulation	Reg_{load}	All outputs, $0 \leq I_o \leq I_{o,max}$		—	± 0.1	± 0.5	% V_o
Total Output Voltage Variation	$\Delta V_o, \text{tol}$	Includes set-point, line, load, $-40^\circ\text{C} \leq T_a \leq +85^\circ\text{C}$	V_{o1} V_{o2}/V_{o3}	— —	— —	± 3 (3) ± 3 (3)	% V_o
Efficiency	η	$I_{o1} = 6\text{A}$, $I_{o2} = 2\text{A}$, $I_{o3} = 2\text{A}$		—	85.6	—	%
V_o Ripple/Noise (0 to 20MHz bandwidth)	V_n		V_{o1} V_{o2} V_{o3}	— — —	35 25 25	— — —	mV _{pp}
Transient Response	t_{tr} V_{os}	0.1A/ μs load step, 50% to 75% $I_{o,max}$ V_o over/undershoot		— —	200 3	— —	μSec % V_o
Output Adjust Range	$V_{o,adj}$		$V_{o1}/V_{o2}/V_{o3}$	—	± 10	—	% V_o
Over-Current Threshold	I_{TRIP}	Total, all outputs. Reset with auto-recovery		—	14	—	A
Switching Frequency	f_s	Over V_{in} and I_o ranges		350	400	450	kHz
Under Voltage Lockout	V_{on} V_{off}	V_{in} increasing V_{in} decreasing		— —	35.5 34	— —	V
Turn-On Time	t_{on}	$V_{in} = 48\text{V}$ step		—	140 (4)	—	ms
Enable Control (pins 1 & 2) High-Level Input Voltage Low-Level Input Voltage Low-Level Input Current	V_{IH} V_{IL} I_{IL}	Referenced to $-V_{in}$ (pin 4)		4 -0.2	— —	15 (5) 0.8	V
Standby Input Current	$I_{in, standby}$	pins 1 & 2 open circuit		—	1	5	mA
Internal Input Capacitance	C_{int}			—	1.14	—	μF
External Output Capacitance	C_{o1} C_{o2} C_{o3}			0 0 0	220 220 220	1,000 (6) 1,000 (6) 1,000 (6)	μF
Primary/Secondary Isolation	V_{iso} C_{iso} R_{iso}			1500 — 10	— 2,200 —	— — —	V pF M Ω

- Notes:** (1) The converter will operate down to no load with reduced specifications.
(2) The sum-total current from outputs V_{o1} , V_{o2} , and V_{o3} cannot exceed 12ADC.
(3) Limits are specified by design.
(4) Measured from the application of the input voltage to the instance that all outputs are in regulation.
(5) The Enable inputs (pins 1 & 2) have internal pull-ups. Leaving pin 1 open-circuit and connecting pin 2 to $-V_{in}$ allows the the converter to operate when input power is applied. The maximum open-circuit voltage is 4V.
(6) Ultra-low ESR capacitors, such as organic or polymer aluminum electrolytic types, may cause instability. Consult the factory before using.

PT4823 Performance Characteristics (See Notes A, B)

PT4823 Thermal Performance (See Note C)
($I_{o1} + I_{o2} + I_{o3} = 12A$, represents 100% Load)

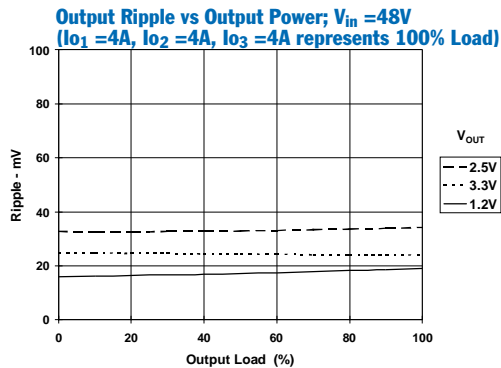
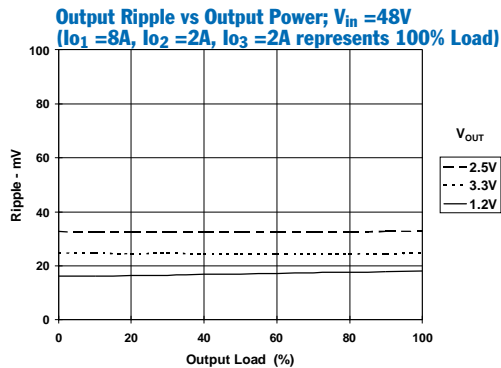
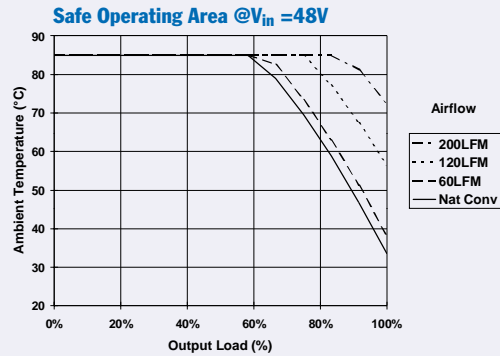
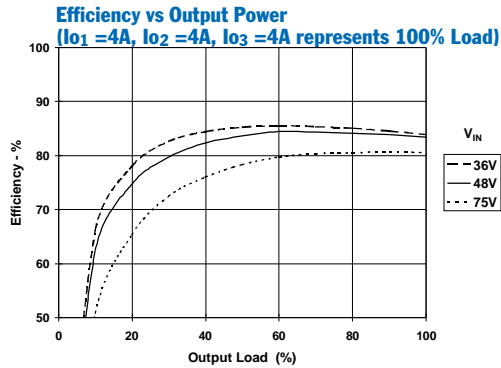
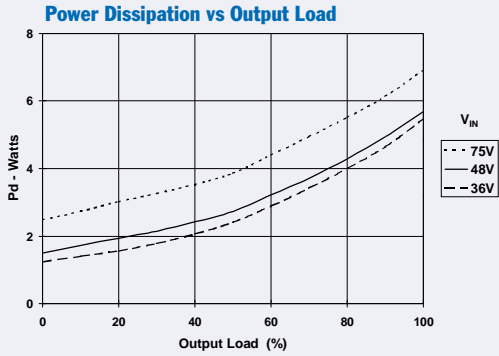
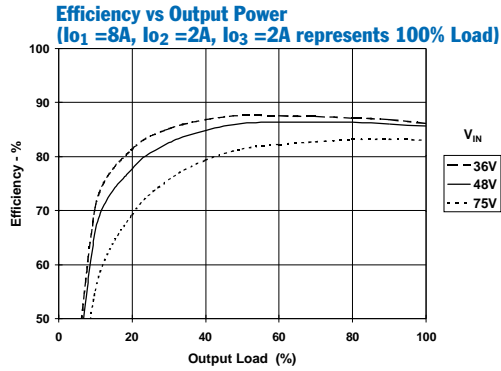

Note A: All Characteristic data in the above graphs has been developed from actual products tested at 25°C. This data is considered typical data for the ISR.
Note B: Output Load (%) represents the percent drawn from each output of the stated 100% load condition.
Note C: SOA curves represent operating conditions at which the internal components are at or below the manufacturer's maximum rated operating temperatures.

PT4824 Electrical Specifications (Unless otherwise stated, the operating conditions are: $T_a = 25^\circ\text{C}$, $V_{in} = 48\text{V}$, and $I_o = 0.5I_{o,max}$)

Characteristics	Symbols	Conditions	PT4824			Units	
			Min	Typ	Max		
Output Current	I_o	Each output	I_{o1} (3.3V) I_{o2} (1.8V) I_{o3} (1.2V)	0.25 (1) 0.1 (1) 0.1 (1)	— — —	8 (2) 6 (2) 6 (2)	A
		Total ($I_{o1} + I_{o2} + I_{o3}$)		—	—	12 (2)	A
Input Voltage Range	V_{in}	Continuous Surge (1 minute)		36 —	— —	75 80	V
Set-Point Voltage	V_o		V_{o1} V_{o2} V_{o3}	3.24 1.76 1.17	3.3 1.8 1.2	3.36 1.84 1.23	V
Temperature Variation	Reg_{temp}	$-40^\circ\text{C} \leq T_a \leq +85^\circ\text{C}$, $I_o = I_{o,min}$	V_{o1} V_{o2}/V_{o3}	— —	± 0.5 ± 0.5	— —	% V_o
Line Regulation	Reg_{line}	All outputs, Over V_{in} range		—	± 0.1	± 0.5	% V_o
Load Regulation	Reg_{load}	All outputs, $0 \leq I_o \leq I_{o,max}$		—	± 0.1	± 0.5	% V_o
Total Output Voltage Variation	$\Delta V_o, \text{tol}$	Includes set-point, line, load, $-40^\circ\text{C} \leq T_a \leq +85^\circ\text{C}$	V_{o1} V_{o2}/V_{o3}	— —	— —	± 3 (3) ± 3 (3)	% V_o
Efficiency	η	$I_{o1} = 6\text{A}$, $I_{o2} = 2\text{A}$, $I_{o3} = 2\text{A}$		—	85	—	%
V_o Ripple/Noise (0 to 20MHz bandwidth)	V_n		V_{o1} V_{o2} V_{o3}	— — —	30 25 25	— — —	mV _{pp}
Transient Response	t_{tr} V_{os}	0.1A/ μs load step, 50% to 75% $I_{o,max}$ V_o over/undershoot		— —	200 3	— —	μSec % V_o
Output Adjust Range	$V_{o,adj}$		$V_{o1}/V_{o2}/V_{o3}$	—	± 10	—	% V_o
Over-Current Threshold	I_{TRIP}	Total, all outputs. Reset with auto-recovery		—	14	—	A
Switching Frequency	f_s	Over V_{in} and I_o ranges		350	400	450	kHz
Under Voltage Lockout	V_{on} V_{off}	V_{in} increasing V_{in} decreasing		— —	35.5 34	— —	V
Turn-On Time	t_{on}	$V_{in} = 48\text{V}$ step		—	140 (4)	—	ms
Enable Control (pins 1 & 2) High-Level Input Voltage Low-Level Input Voltage Low-Level Input Current	V_{IH} V_{IL} I_{IL}	Referenced to $-V_{in}$ (pin 4)		4 -0.2	— —	15 (5) 0.8	V
Standby Input Current	$I_{in, standby}$	pins 1 & 2 open circuit		—	1	5	mA
Internal Input Capacitance	C_{int}			—	1.14	—	μF
External Output Capacitance	C_{o1} C_{o2} C_{o3}			0 0 0	220 220 220	1,000 (6) 1,000 (6) 1,000 (6)	μF
Primary/Secondary Isolation	V_{iso} C_{iso} R_{iso}			1500 — 10	— 2,200 —	— — —	V pF M Ω

- Notes:** (1) The converter will operate down to no load with reduced specifications.
(2) The sum-total current from outputs V_{o1} , V_{o2} , and V_{o3} cannot exceed 12ADC.
(3) Limits are specified by design.
(4) Measured from the application of the input voltage to the instance that all outputs are in regulation.
(5) The Enable inputs (pins 1 & 2) have internal pull-ups. Leaving pin 1 open-circuit and connecting pin 2 to $-V_{in}$ allows the the converter to operate when input power is applied. The maximum open-circuit voltage is 4V.
(6) Ultra-low ESR capacitors, such as organic or polymer aluminum electrolytic types, may cause instability. Consult the factory before using.

PT4824 Performance Characteristics (See Notes A, B)

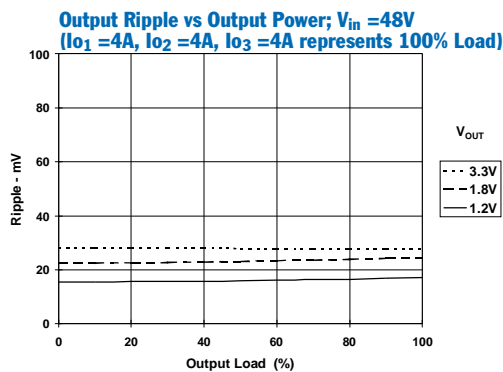
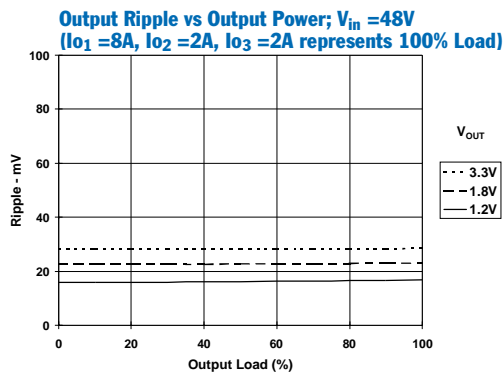
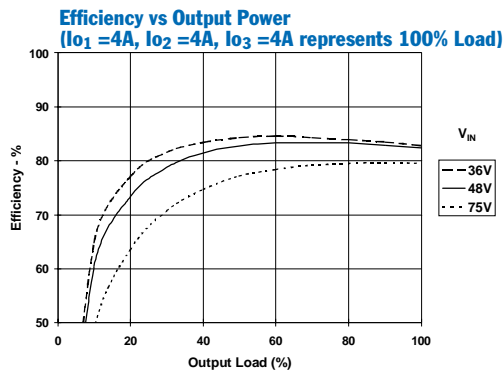
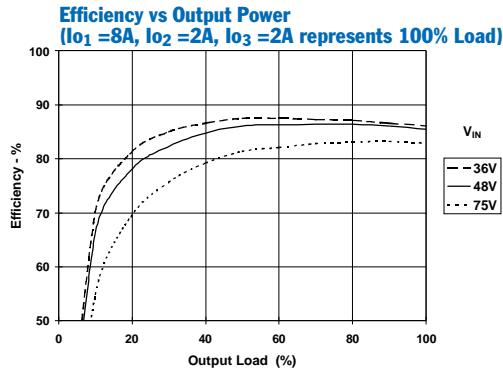

PT4824 Thermal Performance (See Note C)
($I_{O1} + I_{O2} + I_{O3} = 12A$, represents 100% Load)

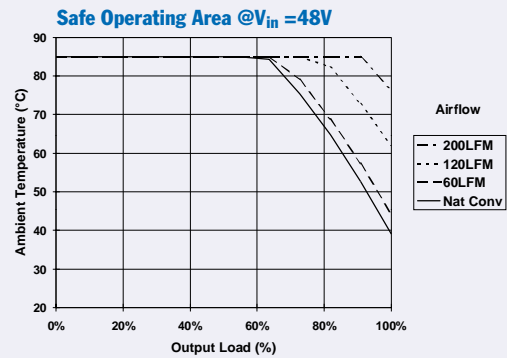
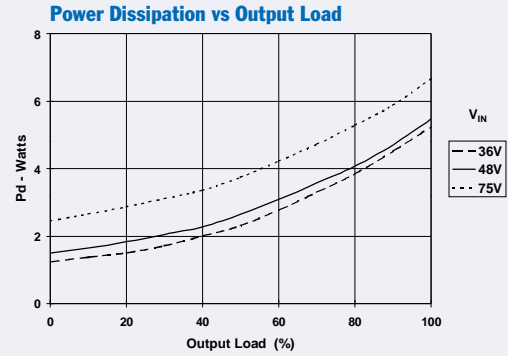

Note A: All Characteristic data in the above graphs has been developed from actual products tested at 25°C. This data is considered typical data for the ISR.
Note B: Output Load (%) represents the percent drawn from each output of the stated 100% load condition.
Note C: SOA curves represent operating conditions at which the internal components are at or below the manufacturer's maximum rated operating temperatures.

PT4825 Electrical Specifications (Unless otherwise stated, the operating conditions are: $T_a = 25^\circ\text{C}$, $V_{in} = 48\text{V}$, and $I_o = 0.5I_{o,max}$)

Characteristics	Symbols	Conditions	PT4825			Units	
			Min	Typ	Max		
Output Current	I_o	Each output	I_{o1} (3.3V) I_{o2} (1.5V) I_{o3} (1.2V)	0.25 (1) 0.1 (1) 0.1 (1)	— — —	8 (2) 6 (2) 6 (2)	A
		Total ($I_{o1} + I_{o2} + I_{o3}$)		—	—	12 (2)	A
Input Voltage Range	V_{in}	Continuous Surge (1 minute)		36 —	— —	75 80	V
Set-Point Voltage	V_o		V_{o1} V_{o2} V_{o3}	3.24 1.47 1.17	3.3 1.5 1.2	3.36 1.53 1.23	V
Temperature Variation	Reg_{temp}	$-40^\circ\text{C} \leq T_a \leq +85^\circ\text{C}$, $I_o = I_{o,min}$	V_{o1} V_{o2}/V_{o3}	— —	± 0.5 ± 0.5	— —	% V_o
Line Regulation	Reg_{line}	All outputs, Over V_{in} range		—	± 0.1	± 0.5	% V_o
Load Regulation	Reg_{load}	All outputs, $0 \leq I_o \leq I_{o,max}$		—	± 0.1	± 0.5	% V_o
Total Output Voltage Variation	$\Delta V_o, \text{tol}$	Includes set-point, line, load, $-40^\circ\text{C} \leq T_a \leq +85^\circ\text{C}$	V_{o1} V_{o2}/V_{o3}	— —	— —	± 3 (3) ± 3 (3)	% V_o
Efficiency	η	$I_{o1} = 6\text{A}$, $I_{o2} = 2\text{A}$, $I_{o3} = 2\text{A}$		—	86	—	%
V_o Ripple/Noise (0 to 20MHz bandwidth)	V_n		V_{o1} V_{o2} V_{o3}	— — —	35 25 25	— — —	mV _{pp}
Transient Response	t_{tr} V_{os}	0.1A/ μs load step, 50% to 75% $I_{o,max}$ V_o over/undershoot		— —	200 3	— —	μSec % V_o
Output Adjust Range	$V_{o,adj}$		$V_{o1}/V_{o2}/V_{o3}$	—	± 10	—	% V_o
Over-Current Threshold	I_{TRIP}	Total, all outputs. Reset with auto-recovery		—	14	—	A
Switching Frequency	f_s	Over V_{in} and I_o ranges		350	400	450	kHz
Under Voltage Lockout	V_{on} V_{off}	V_{in} increasing V_{in} decreasing		— —	35.5 34	— —	V
Turn-On Time	t_{on}	$V_{in} = 48\text{V}$ step		—	140 (4)	—	ms
Enable Control (pins 1 & 2) High-Level Input Voltage Low-Level Input Voltage Low-Level Input Current	V_{IH} V_{IL} I_{IL}	Referenced to $-V_{in}$ (pin 4)		4 -0.2	— —	15 (5) 0.8	V
Standby Input Current	$I_{in, standby}$	pins 1 & 2 open circuit		—	1	5	mA
Internal Input Capacitance	C_{int}			—	1.14	—	μF
External Output Capacitance	C_{o1} C_{o2} C_{o3}			0 0 0	220 220 220	1,000 (6) 1,000 (6) 1,000 (6)	μF
Primary/Secondary Isolation	V_{iso} C_{iso} R_{iso}			1500 — 10	— 2,200 —	— — —	V pF M Ω

- Notes:** (1) The converter will operate down to no load with reduced specifications.
(2) The sum-total current from outputs V_{o1} , V_{o2} , and V_{o3} not to exceed 12ADC.
(3) Limits are specified by design.
(4) Measured from the application of the input voltage to the instance that all outputs are in regulation.
(5) The Enable inputs (pins 1 & 2) have internal pull-ups. Leaving pin 1 open-circuit and connecting pin 2 to $-V_{in}$ allows the the converter to operate when input power is applied. The maximum open-circuit voltage is 4V.
(6) Ultra-low ESR capacitors, such as organic or polymer aluminum electrolytic types, may cause instability. Consult the factory before using.

PT4825 Performance Characteristics (See Notes A, B)

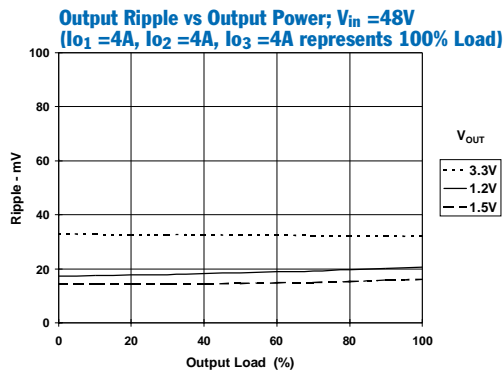
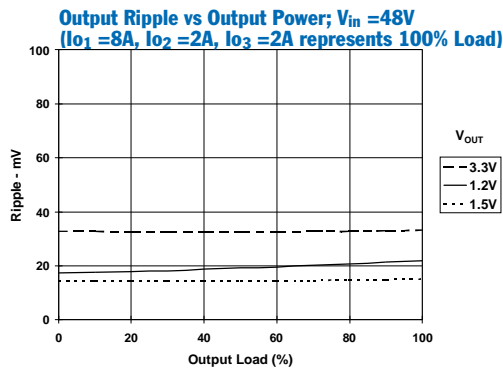
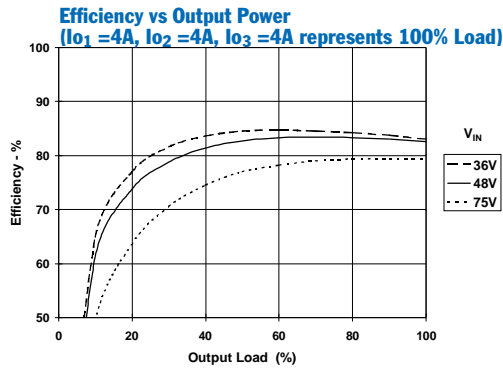
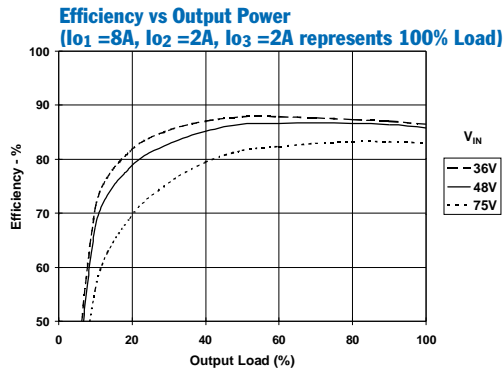

PT4825 Thermal Performance (See Note C)
($I_{o1} + I_{o2} + I_{o3} = 12A$, represents 100% Load)

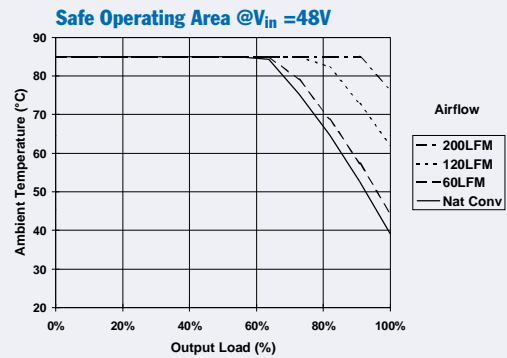
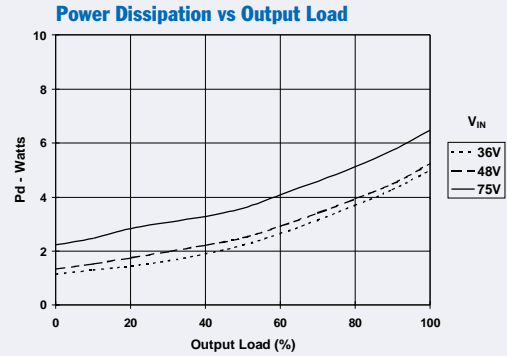

Note A: All Characteristic data in the above graphs has been developed from actual products tested at 25°C. This data is considered typical data for the ISR.
Note B: Output Load (%) represents the percent drawn from each output of the stated 100% load condition.
Note C: SOA curves represent operating conditions at which the internal components are at or below the manufacturer's maximum rated operating temperatures.

PT4826 Electrical Specifications (Unless otherwise stated, the operating conditions are: $T_a = 25^\circ\text{C}$, $V_{in} = 48\text{V}$, and $I_o = 0.5I_{o,max}$)

Characteristics	Symbols	Conditions	PT4826			Units	
			Min	Typ	Max		
Output Current	I_o	Each output	$I_{o1} (5.0\text{V})$	0.25 (1)	—	5.0 (2)	A
			$I_{o2} (3.3\text{V})$	0.1 (1)	—	5.5 (2)	
			$I_{o3} (1.8\text{V})$	0.1 (1)	—	5.5 (2)	
		Total ($I_{o1} + I_{o2} + I_{o3}$)		—	—	9 (2)	A
Input Voltage Range	V_{in}	Continuous		36	—	75	V
			Surge (1 minute)		—	—	
Set-Point Voltage	V_o		V_{o1}	4.9	5.0	5.1	V
			V_{o2}	3.24	3.3	3.36	
			V_{o3}	1.76	1.8	1.84	
Temperature Variation	Reg_{temp}	$-40^\circ\text{C} \leq T_a \leq 85^\circ\text{C}$, $I_o = I_{o,min}$	V_{o1}	—	± 0.5	—	$\%V_o$
			V_{o2}/V_{o3}	—	± 0.5	—	
Line Regulation	Reg_{line}	All outputs, Over V_{in} range		—	± 0.1	± 0.5	$\%V_o$
Load Regulation	Reg_{load}	All outputs, $0 \leq I_o \leq I_{o,max}$		—	± 0.1	± 0.5	$\%V_o$
Total Output Voltage Variation	$\Delta V_o, \text{tol}$	Includes set-point, line, load, $-40^\circ\text{C} \leq T_a \leq 85^\circ\text{C}$	V_{o1}	—	—	± 3 (3)	$\%V_o$
			V_{o2}/V_{o3}	—	—	± 3 (3)	
Efficiency	η	$I_{o1} = 5\text{A}$, $I_{o2} = 2\text{A}$, $I_{o3} = 2\text{A}$		—	87	—	%
V_o Ripple/Noise (0 to 20MHz bandwidth)	V_n		V_{o1}	—	40	—	mV _{pp}
			V_{o2}	—	35	—	
			V_{o3}	—	25	—	
Transient Response	t_{tr} V_{os}	0.1A/ μs load step, 50% to 75% $I_{o,max}$ V_o over/undershoot		—	200	—	μSec $\%V_o$
				—	5	—	
Output Adjust Range	$V_{o,adj}$		$V_{o1}/V_{o2}/V_{o3}$	—	± 10	—	$\%V_o$
Over-Current Threshold	I_{TRIP}	Total, all outputs. Reset with auto-recovery		—	11	—	A
Switching Frequency	f_s	Over V_{in} and I_o ranges		350	400	450	kHz
Under Voltage Lockout	V_{on} V_{off}	V_{in} increasing V_{in} decreasing		—	35.5	—	V
				—	34	—	
Turn-On Time	t_{on}	$V_{in} = 48\text{V}$ step		—	140 (4)	—	ms
Enable Control (pins 1 & 2) High-Level Input Voltage Low-Level Input Voltage	V_{IH} V_{IL}	Referenced to $-V_{in}$ (pin 4)		4	—	15 (5)	V
				-0.2	—	0.8	
Low-Level Input Current	I_{IL}			—	1	2	mA
Standby Input Current	$I_{in, standby}$	pins 1 & 2 open circuit		—	1	5	mA
Internal Input Capacitance	C_{int}			—	1.14	—	μF
External Output Capacitance	C_{o1} C_{o2} C_{o3}			0	220	1,000 (6)	μF
				0	220	1,000 (6)	
				0	220	1,000 (6)	
Primary/Secondary Isolation	V_{iso} C_{iso} R_{iso}			1500	—	—	V pF M Ω
				—	2,200	—	
				10	—	—	

Notes: (1) The converter will operate down to no load with reduced specifications.

(2) The sum-total current from outputs V_{o1} , V_{o2} , and V_{o3} cannot exceed 9ADC.

(3) Limits are specified by design.

(4) Measured from the application of the input voltage to the instance that all outputs are in regulation.

(5) The Enable inputs (pins 1 & 2) have internal pull-ups. Leaving pin 1 open-circuit and connecting pin 2 to $-V_{in}$ allows the the converter to operate when input power is applied. The maximum open-circuit voltage is 4V.

(6) Ultra-low ESR capacitors, such as organic or polymer aluminum electrolytic types, may cause instability. Consult the factory before using.

PT4826 Performance Characteristics (See Notes A, B)

PT4826 Thermal Performance (See Note C)
($I_{o1} + I_{o2} + I_{o3} = 9A$, represents 100% Load)

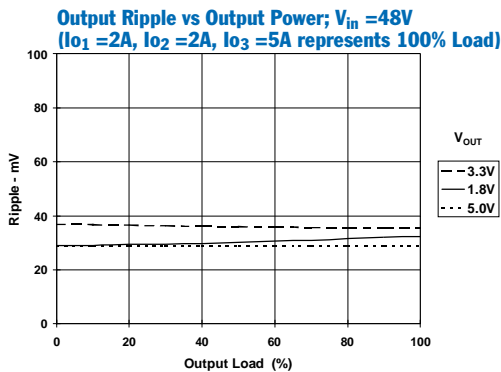
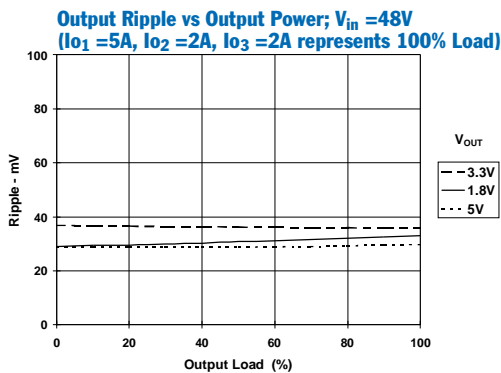
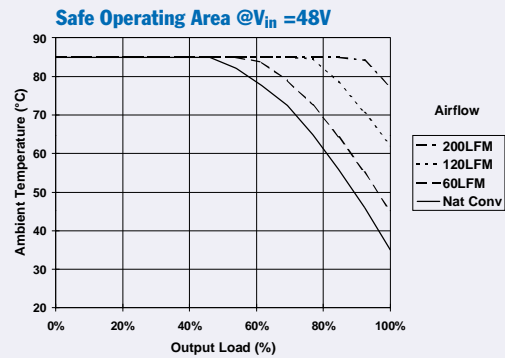
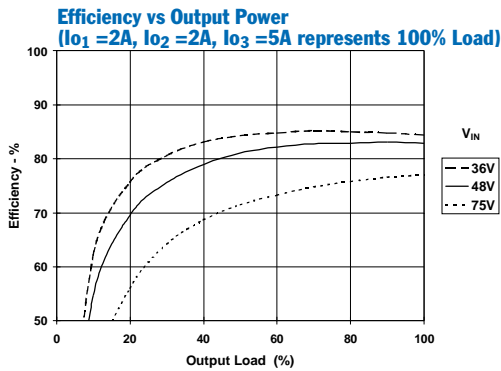
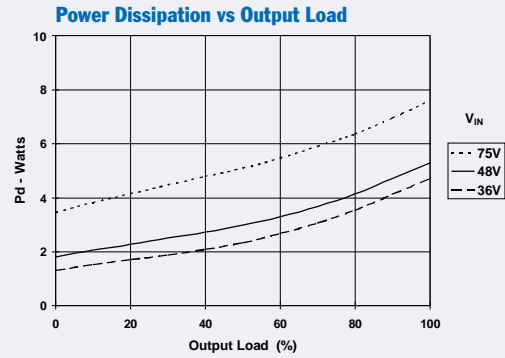
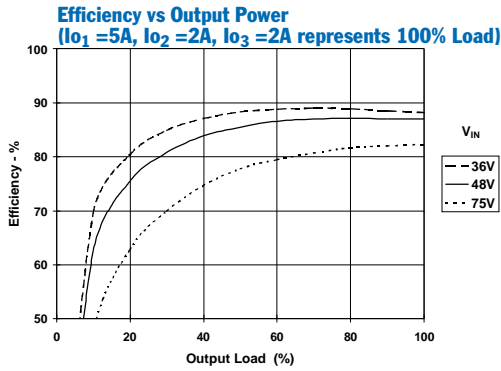

Note A: All Characteristic data in the above graphs has been developed from actual products tested at 25°C. This data is considered typical data for the ISR.
Note B: Output Load (%) represents the percent drawn from each output of the stated 100% load condition.
Note C: SOA curves represent operating conditions at which the internal components are at or below the manufacturer's maximum rated operating temperatures.

PT4827 Electrical Specifications (Unless otherwise stated, the operating conditions are: $T_a = 25^\circ\text{C}$, $V_{in} = 48\text{V}$, and $I_o = 0.5I_{o,max}$)

Characteristics	Symbols	Conditions	PT4827			Units	
			Min	Typ	Max		
Output Current	I_o	Each output	I_{o1} (3.3V) I_{o2} (2.5V) I_{o3} (1.8V)	0.25 (1) 0.1 (1) 0.1 (1)	— — —	8 (2) 6 (2) 6 (2)	A
		Total ($I_{o1} + I_{o2} + I_{o3}$)		—	—	12 (2)	A
Input Voltage Range	V_{in}	Continuous Surge (1 minute)		36 —	— —	75 80	V
Set-Point Voltage	V_o		V_{o1} V_{o2} V_{o3}	3.24 2.45 1.76	3.3 2.5 1.8	3.36 2.55 1.84	V
Temperature Variation	Reg_{temp}	$-40^\circ\text{C} \leq T_a \leq +85^\circ\text{C}$, $I_o = I_{o,min}$	V_{o1} V_{o2}/V_{o3}	— —	± 0.5 ± 0.5	— —	% V_o
Line Regulation	Reg_{line}	All outputs, Over V_{in} range		—	± 0.1	± 0.5	% V_o
Load Regulation	Reg_{load}	All outputs, $0 \leq I_o \leq I_{o,max}$		—	± 0.1	± 0.5	% V_o
Total Output Voltage Variation	$\Delta V_o, \text{tol}$	Includes set-point, line, load, $-40^\circ\text{C} \leq T_a \leq +85^\circ\text{C}$	V_{o1} V_{o2}/V_{o3}	— —	— —	± 3 (3) ± 3 (3)	% V_o
Efficiency	η	$I_{o1} = 6\text{A}$, $I_{o2} = 2\text{A}$, $I_{o3} = 2\text{A}$		—	86	—	%
V_o Ripple/Noise (0 to 20MHz bandwidth)	V_n		V_{o1} V_{o2} V_{o3}	— — —	40 35 25	— — —	mV _{pp}
Transient Response	t_{tr} V_{os}	0.1A/ μs load step, 50% to 75% $I_{o,max}$ V_o over/undershoot		— —	200 3	— —	μSec % V_o
Output Adjust Range	$V_{o,adj}$		$V_{o1}/V_{o2}/V_{o3}$	—	± 10	—	% V_o
Over-Current Threshold	I_{TRIP}	Total, all outputs. Reset with auto-recovery		—	14	—	A
Switching Frequency	f_s	Over V_{in} and I_o ranges		350	400	450	kHz
Under Voltage Lockout	V_{on} V_{off}	V_{in} increasing V_{in} decreasing		— —	35.5 34	— —	V
Turn-On Time	t_{on}	$V_{in} = 48\text{V}$ step		—	140 (4)	—	ms
Enable Control (pins 1 & 2) High-Level Input Voltage Low-Level Input Voltage Low-Level Input Current	V_{IH} V_{IL} I_{IL}	Referenced to $-V_{in}$ (pin 4)		4 -0.2	— —	15 (5) 0.8	V mA
Standby Input Current	$I_{in, standby}$	pins 1 & 2 open circuit		—	1	5	mA
Internal Input Capacitance	C_{int}			—	1.14	—	μF
External Output Capacitance	C_{o1} C_{o2} C_{o3}			0 0 0	220 220 220	1,000 (6) 1,000 (6) 1,000 (6)	μF
Primary/Secondary Isolation	V_{iso} C_{iso} R_{iso}			1500 — 10	— 2,200 —	— — —	V pF M Ω

- Notes:** (1) The converter will operate down to no load with reduced specifications.
(2) The sum-total current from outputs V_{o1} , V_{o2} , and V_{o3} cannot exceed 12ADC.
(3) Limits are specified by design.
(4) Measured from the application of the input voltage to the instance that all outputs are in regulation.
(5) The Enable inputs (pins 1 & 2) have internal pull-ups. Leaving pin 1 open-circuit and connecting pin 2 to $-V_{in}$ allows the the converter to operate when input power is applied. The maximum open-circuit voltage is 4V.
(6) Ultra-low ESR capacitors, such as organic or polymer aluminum electrolytic types, may cause instability. Consult the factory before using.

PT4827 Performance Characteristics (See Notes A, B)

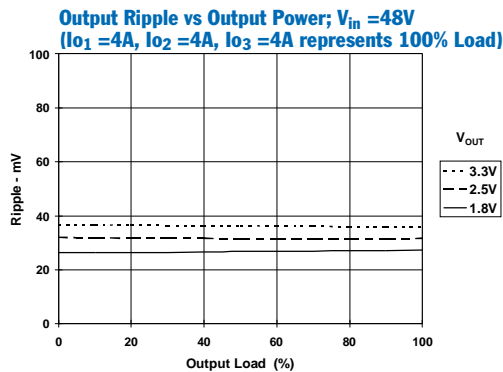
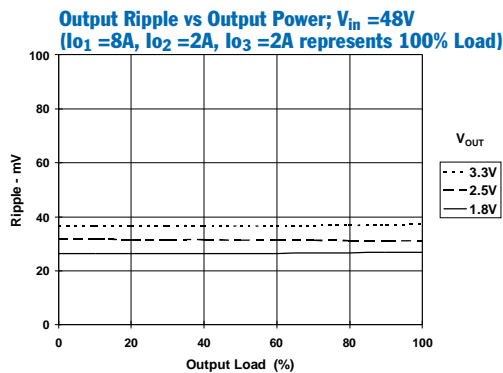
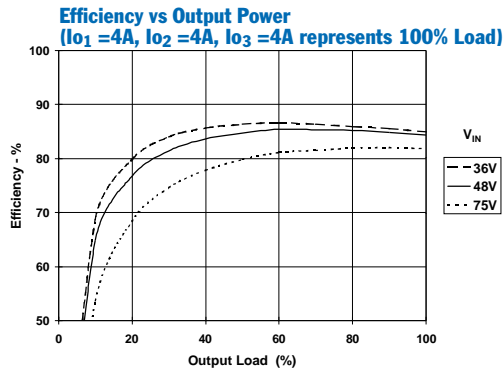
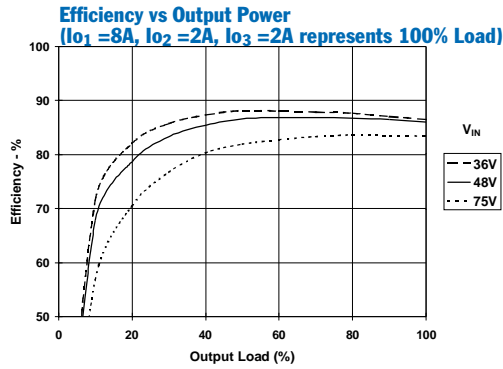

PT4827 Thermal Performance (See Note C)
($I_{O1} + I_{O2} + I_{O3} = 12A$, represents 100% Load)

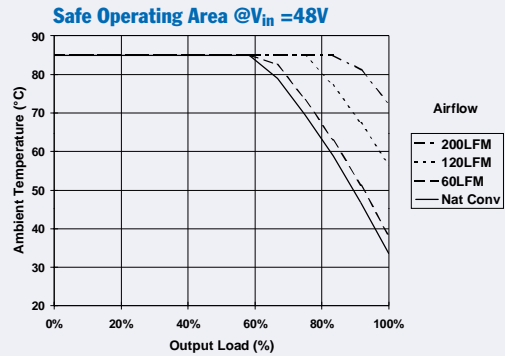
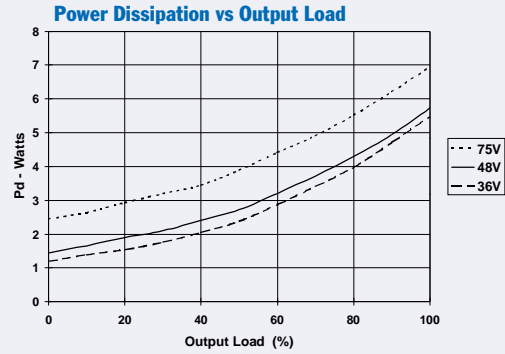

Note A: All Characteristic data in the above graphs has been developed from actual products tested at 25°C. This data is considered typical data for the ISR.
Note B: Output Load (%) represents the percent drawn from each output of the stated 100% load condition.
Note C: SOA curves represent operating conditions at which the internal components are at or below the manufacturer's maximum rated operating temperatures.

PT4828 Electrical Specifications (Unless otherwise stated, the operating conditions are: $T_a = 25^\circ\text{C}$, $V_{in} = 48\text{V}$, and $I_o = 0.5I_{o,max}$)

Characteristics	Symbols	Conditions	PT4828			Units	
			Min	Typ	Max		
Output Current	I_o	Each output	$I_{o1} (5.0\text{V})$	0.25 (1)	—	5.0 (2)	A
			$I_{o2} (2.5\text{V})$ $I_{o3} (1.5\text{V})$	0.1 (1)	—	5.5 (2)	
		Total ($I_{o1} + I_{o2} + I_{o3}$)	—	—	9 (2)	A	
Input Voltage Range	V_{in}	Continuous Surge (1 minute)		36	—	75	V
				—	—	80	
Set-Point Voltage	V_o		V_{o1}	4.9	5.0	5.1	V
			V_{o2}	2.45	2.5	2.55	
			V_{o3}	1.47	1.5	1.53	
Temperature Variation	Reg_{temp}	$-40^\circ\text{C} \leq T_a \leq +85^\circ\text{C}$, $I_o = I_{o,min}$	V_{o1}	—	± 0.5	—	% V_o
			V_{o2}/V_{o3}	—	± 0.5	—	
Line Regulation	Reg_{line}	All outputs, Over V_{in} range		—	± 0.1	± 0.5	% V_o
Load Regulation	Reg_{load}	All outputs, $0 \leq I_o \leq I_{o,max}$		—	± 0.1	± 0.5	% V_o
Total Output Voltage Variation	$\Delta V_o, \text{tol}$	Includes set-point, line, load, $-40^\circ\text{C} \leq T_a \leq +85^\circ\text{C}$	V_{o1}	—	—	± 3 (3)	% V_o
			V_{o2}/V_{o3}	—	—	± 3 (3)	
Efficiency	η	$I_{o1} = 5\text{A}$, $I_{o2} = 2\text{A}$, $I_{o3} = 2\text{A}$		—	86.5	—	%
V_o Ripple/Noise (0 to 20MHz bandwidth)	V_n		V_{o1}	—	30	—	mV _{pp}
			V_{o2}	—	30	—	
			V_{o3}	—	25	—	
Transient Response	t_{tr} V_{os}	0.1A/ μs load step, 50% to 75% $I_{o,max}$ V_o over/undershoot		—	200	—	μSec % V_o
				—	5	—	
Output Adjust Range	$V_{o,adj}$		$V_{o1}/V_{o2}/V_{o3}$	—	± 10	—	% V_o
Over-Current Threshold	I_{TRIP}	Total, all outputs. Reset with auto-recovery		—	11	—	A
Switching Frequency	f_s	Over V_{in} and I_o ranges		350	400	450	kHz
Under Voltage Lockout	V_{on} V_{off}	V_{in} increasing V_{in} decreasing		—	35.5	—	V
				—	34	—	
Turn-On Time	t_{on}	$V_{in} = 48\text{V}$ step		—	140 (4)	—	ms
Enable Control (pins 1 & 2) High-Level Input Voltage Low-Level Input Voltage Low-Level Input Current	V_{IH} V_{IL} I_{IL}	Referenced to $-V_{in}$ (pin 4)		4	—	15 (5)	V
				-0.2	—	0.8	
				—	1	2	mA
Standby Input Current	$I_{in, standby}$	pins 1 & 2 open circuit		—	1	5	mA
Internal Input Capacitance	C_{int}			—	1.14	—	μF
External Output Capacitance	C_{o1} C_{o2} C_{o3}			0	220	1,000 (6)	μF
				0	220	1,000 (6)	
				0	220	1,000 (6)	
Primary/Secondary Isolation	V_{iso} C_{iso} R_{iso}			1500	—	—	V pF M Ω
				—	2,200	—	
				10	—	—	

Notes: (1) The converter will operate down to no load with reduced specifications.

(2) The sum-total current from outputs V_{o2} , and V_{o3} cannot exceed 9ADC.

(3) Limits are specified by design.

(4) Measured from the application of the input voltage to the instance that all outputs are in regulation.

(5) The Enable inputs (pins 1 & 2) have internal pull-ups. Leaving pin 1 open-circuit and connecting pin 2 to $-V_{in}$ allows the the converter to operate when input power is applied. The maximum open-circuit voltage is 4V.

(6) Ultra-low ESR capacitors, such as organic or polymer aluminum electrolytic types, may cause instability. Consult the factory before using.

PT4828 Performance Characteristics (See Notes A, B)

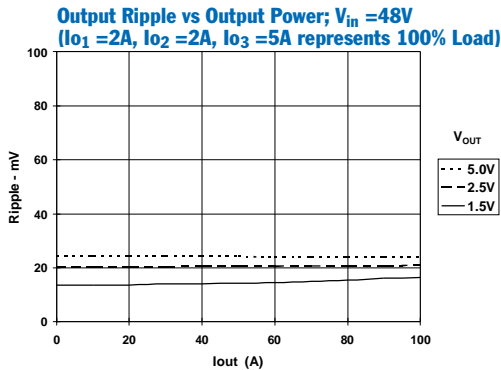
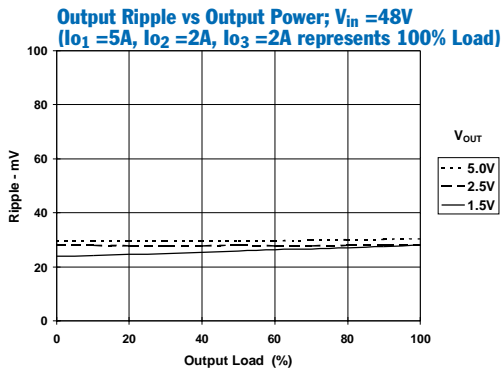
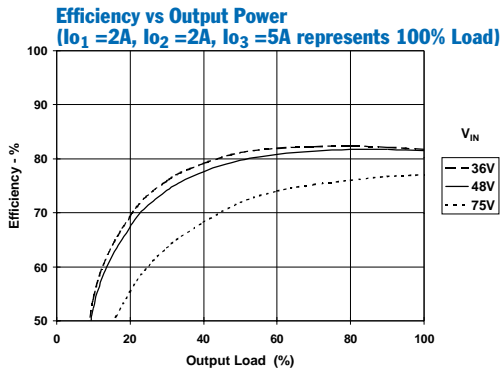
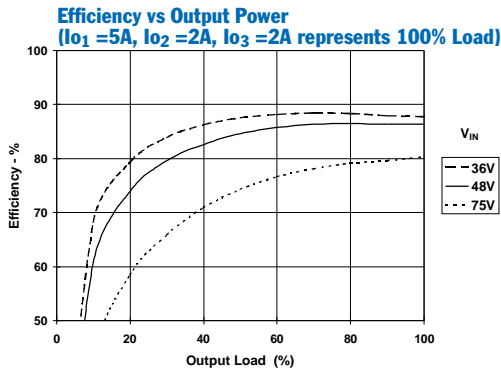

PT4828 Thermal Performance (See Note C)
($I_{o1} + I_{o2} + I_{o3} = 9A$, represents 100% Load)

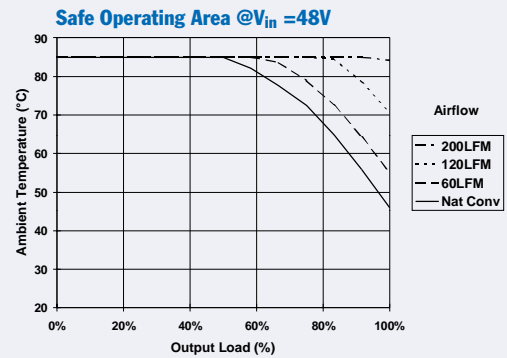
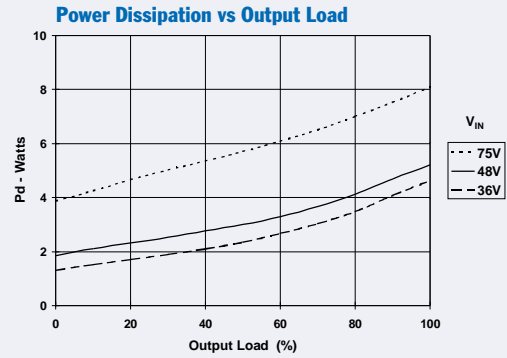

Note A: All Characteristic data in the above graphs has been developed from actual products tested at 25°C. This data is considered typical data for the ISR.
Note B: Output Load (%) represents the percent drawn from each output of the stated 100% load condition.
Note C: SOA curves represent operating conditions at which the internal components are at or below the manufacturer's maximum rated operating temperatures.

PT4829 Electrical Specifications (Unless otherwise stated, the operating conditions are: $T_a = 25^\circ\text{C}$, $V_{in} = 48\text{V}$, and $I_o = 0.5I_{o,max}$)

Characteristics	Symbols	Conditions	PT4829			Units	
			Min	Typ	Max		
Output Current	I_o	Each output	$I_{o1} (5.0\text{V})$	0.25 (1)	—	5.0 (2)	A
			$I_{o2} (1.8\text{V})$	0.1 (1)	—	5.5 (2)	
			$I_{o3} (1.5\text{V})$	0.1 (1)	—	5.5 (2)	
		Total ($I_{o1} + I_{o2} + I_{o3}$)		—	—	9 (2)	A
Input Voltage Range	V_{in}	Continuous Surge (1 minute)		36	—	75	V
				—	—	80	
Set-Point Voltage	V_o		V_{o1}	4.9	5.0	5.1	V
			V_{o2}	1.76	1.8	1.84	
			V_{o3}	1.47	1.5	1.53	
Temperature Variation	Reg_{temp}	$-40^\circ\text{C} \leq T_a \leq +85^\circ\text{C}$, $I_o = I_{o,min}$	V_{o1}	—	± 0.5	—	% V_o
			V_{o2}/V_{o3}	—	± 0.5	—	
Line Regulation	Reg_{line}	All outputs, Over V_{in} range		—	± 0.1	± 0.5	% V_o
Load Regulation	Reg_{load}	All outputs, $0 \leq I_o \leq I_{o,max}$		—	± 0.1	± 0.5	% V_o
Total Output Voltage Variation	$\Delta V_o, \text{tol}$	Includes set-point, line, load, $-40^\circ\text{C} \leq T_a \leq +85^\circ\text{C}$	V_{o1}	—	—	± 3 (3)	% V_o
			V_{o2}/V_{o3}	—	—	± 3 (3)	
Efficiency	η	$I_{o1} = 5\text{A}$, $I_{o2} = 2\text{A}$, $I_{o3} = 2\text{A}$		—	86.2	—	%
V_o Ripple/Noise (0 to 20MHz bandwidth)	V_n		V_{o1}	—	35	—	mV _{pp}
			V_{o2}	—	25	—	
			V_{o3}	—	25	—	
Transient Response	t_{tr} V_{os}	0.1A/ μs load step, 50% to 75% $I_{o,max}$ V_o over/undershoot		—	200	—	μSec % V_o
				—	5	—	
Output Adjust Range	$V_{o,adj}$		$V_{o1}/V_{o2}/V_{o3}$	—	± 10	—	% V_o
Over-Current Threshold	I_{TRIP}	Total, all outputs. Reset with auto-recovery		—	11	—	A
Switching Frequency	f_s	Over V_{in} and I_o ranges		350	400	450	kHz
Under Voltage Lockout	V_{on} V_{off}	V_{in} increasing V_{in} decreasing		—	35.5	—	V
				—	34	—	
Turn-On Time	t_{on}	$V_{in} = 48\text{V}$ step		—	140 (4)	—	ms
Enable Control (pins 1 & 2) High-Level Input Voltage Low-Level Input Voltage Low-Level Input Current	V_{IH} V_{IL} I_{IL}	Referenced to $-V_{in}$ (pin 4)		4	—	15 (5)	V
				-0.2	—	0.8	
				—	1	2	
Standby Input Current	$I_{in, standby}$	pins 1 & 2 open circuit		—	1	5	mA
Internal Input Capacitance	C_{int}			—	1.14	—	μF
External Output Capacitance	C_{O1} C_{O2} C_{O3}			0	220	1,000 (6)	μF
				0	220	1,000 (6)	
				0	220	1,000 (6)	
Primary/Secondary Isolation	V_{iso} C_{iso} R_{iso}			1500	—	—	V pF M Ω
				—	2,200	—	
				10	—	—	

- Notes:** (1) The converter will operate down to no load with reduced specifications.
(2) The sum-total current from outputs V_{o2} , and V_{o3} cannot exceed 9ADC.
(3) Limits are specified by design.
(4) Measured from the application of the input voltage to the instance that all outputs are in regulation.
(5) The Enable inputs (pins 1 & 2) have internal pull-ups. Leaving pin 1 open-circuit and connecting pin 2 to $-V_{in}$ allows the the converter to operate when input power is applied. The maximum open-circuit voltage is 4V.
(6) Ultra-low ESR capacitors, such as organic or polymer aluminum electrolytic types, may cause instability. Consult the factory before using.

PT4829 Performance Characteristics (See Notes A, B)

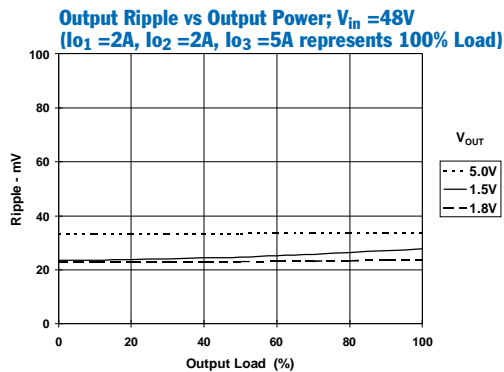
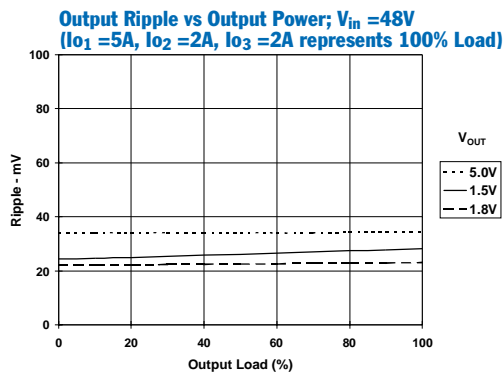
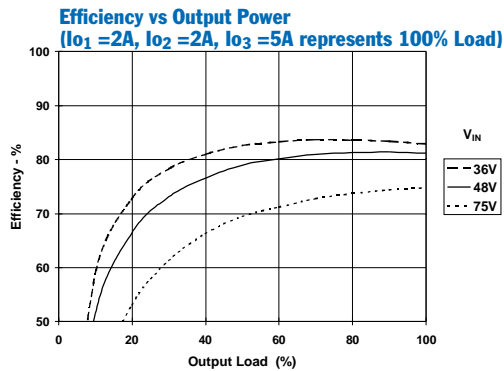
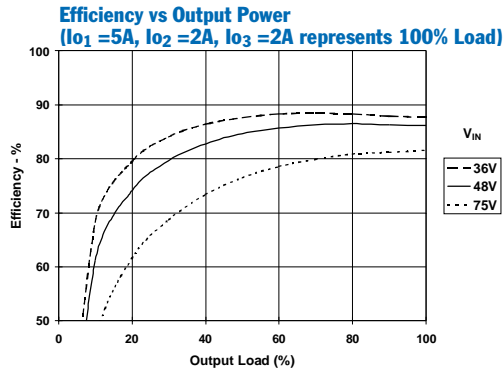

PT4829 Thermal Performance (See Note C)
($I_{O1} + I_{O2} + I_{O3} = 9A$, represents 100% Load)

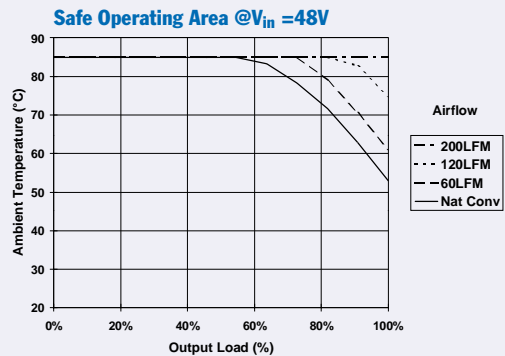
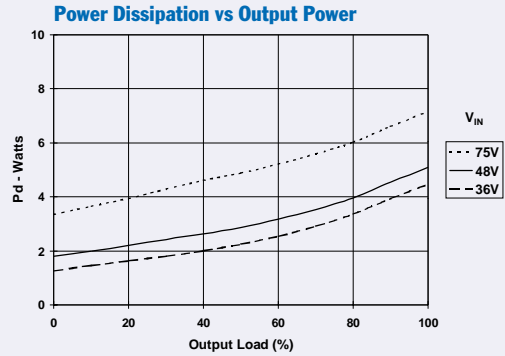

Note A: All Characteristic data in the above graphs has been developed from actual products tested at 25°C. This data is considered typical data for the ISR.

Note B: Output Load (%) represents the percent drawn from each output of the stated 100% load condition.

Note C: SOA curves represent operating conditions at which the internal components are at or below the manufacturer's maximum rated operating temperatures.

PT4831 Electrical Specifications (Unless otherwise stated, the operating conditions are: $T_a = 25^\circ\text{C}$, $V_{in} = 48\text{V}$, and $I_o = 0.5I_{o,max}$)

Characteristics	Symbols	Conditions	PT4831			Units	
			Min	Typ	Max		
Output Current	I_o	Each output	$I_{o1} (5.0\text{V})$ $I_{o2} (3.3\text{V})$ $I_{o3} (1.5\text{V})$	0.25 (1) 0.1 (1) 0.1 (1)	— — —	5.0 (2) 5.5 (2) 5.5 (2)	A
		Total ($I_{o1} + I_{o2} + I_{o3}$)		—	—	9 (2)	A
Input Voltage Range	V_{in}	Continuous Surge (1 minute)	36 —	— —	75 80	V	
Set-Point Voltage	V_o		V_{o1} V_{o2} V_{o3}	4.9 3.24 1.47	5.0 3.3 1.5	5.1 3.36 1.53	V
Temperature Variation	Reg_{temp}	$-40^\circ\text{C} \leq T_a \leq +85^\circ\text{C}$, $I_o = I_{o,min}$	V_{o1} V_{o2}/V_{o3}	— —	± 0.5 ± 0.5	— —	% V_o
Line Regulation	Reg_{line}	All outputs, Over V_{in} range		—	± 0.1	± 0.5	% V_o
Load Regulation	Reg_{load}	All outputs, $0 \leq I_o \leq I_{o,max}$		—	± 0.1	± 0.5	% V_o
Total Output Voltage Variation	$\Delta V_o, \text{tol}$	Includes set-point, line, load, $-40^\circ\text{C} \leq T_a \leq +85^\circ\text{C}$	V_{o1} V_{o2}/V_{o3}	— —	— —	± 3 (3) ± 3 (3)	% V_o
Efficiency	η	$I_{o1} = 5\text{A}$, $I_{o2} = 2\text{A}$, $I_{o3} = 2\text{A}$		—	87	—	%
V_o Ripple/Noise (0 to 20MHz bandwidth)	V_n		V_{o1} V_{o2} V_{o3}	— — —	40 35 25	— — —	mV _{pp}
Transient Response	t_{tr} V_{os}	0.1A/ μs load step, 50% to 75% $I_{o,max}$ V_o over/undershoot		— —	200 5	— —	μSec % V_o
Output Adjust Range	$V_{o,adj}$		$V_{o1}/V_{o2}/V_{o3}$	—	± 10	—	% V_o
Over-Current Threshold	I_{TRIP}	Total, all outputs. Reset with auto-recovery		—	11	—	A
Switching Frequency	f_s	Over V_{in} and I_o ranges		350	400	450	kHz
Under Voltage Lockout	V_{on} V_{off}	V_{in} increasing V_{in} decreasing		— —	35.5 34	— —	V
Turn-On Time	t_{on}	$V_{in} = 48\text{V}$ step		—	140 (4)	—	ms
Enable Control (pins 1 & 2) High-Level Input Voltage Low-Level Input Voltage Low-Level Input Current	V_{IH} V_{IL} I_{IL}	Referenced to $-V_{in}$ (pin 4)		4 -0.2	— —	15 (5) 0.8	V
Standby Input Current	$I_{in, standby}$	pins 1 & 2 open circuit		—	1	5	mA
Internal Input Capacitance	C_{int}			—	1.14	—	μF
External Output Capacitance	C_{o1} C_{o2} C_{o3}			0 0 0	220 220 220	1,000 (6) 1,000 (6) 1,000 (6)	μF
Primary/Secondary Isolation	V_{iso} C_{iso} R_{iso}			1500 — 10	— 2,200 —	— — —	V pF M Ω

- Notes:** (1) The converter will operate down to no load with reduced specifications.
(2) The sum-total current from outputs V_{o1} , V_{o2} , and V_{o3} cannot exceed 9ADC.
(3) Limits are specified by design.
(4) Measured from the application of the input voltage to the instance that all outputs are in regulation.
(5) The Enable inputs (pins 1 & 2) have internal pull-ups. Leaving pin 1 open-circuit and connecting pin 2 to $-V_{in}$ allows the the converter to operate when input power is applied. The maximum open-circuit voltage is 4V.
(6) Ultra-low ESR capacitors, such as organic or polymer aluminum electrolytic types, may cause instability. Consult the factory before using.

PT4831 Performance Characteristics (See Notes A, B)

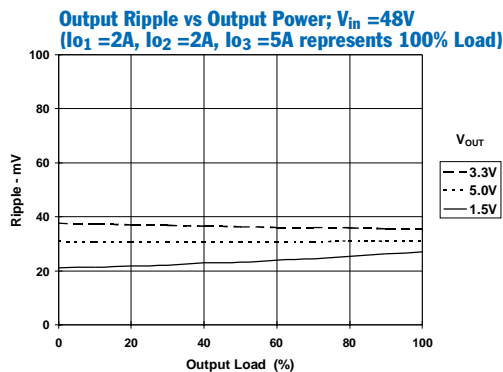
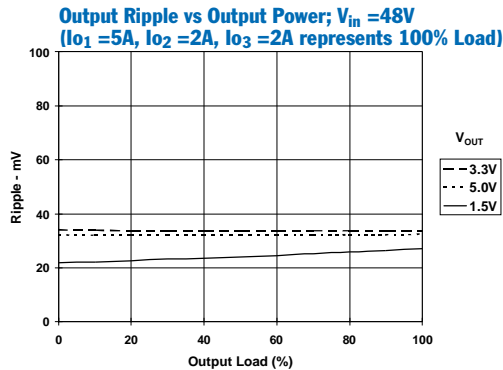
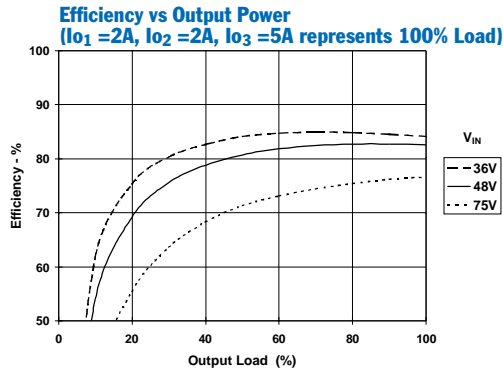
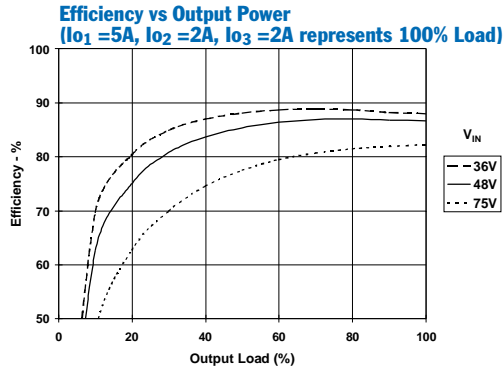

PT4831 Thermal Performance (See Note C)
($I_{o1} + I_{o2} + I_{o3} = 9A$, represents 100% Load)

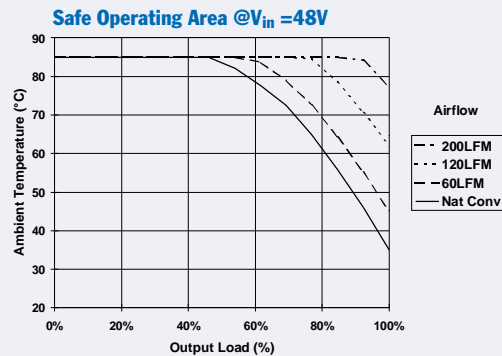
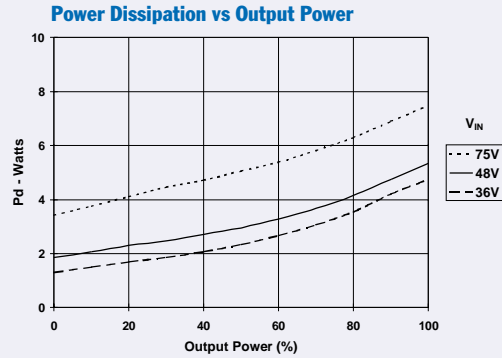

Note A: All Characteristic data in the above graphs has been developed from actual products tested at 25°C. This data is considered typical data for the ISR.
Note B: Output Load (%) represents the percent drawn from each output of the stated 100% load condition.
Note C: SOA curves represent operating conditions at which the internal components are at or below the manufacturer's maximum rated operating temperatures.

PT4832 Electrical Specifications (Unless otherwise stated, the operating conditions are: $T_a = 25^\circ\text{C}$, $V_{in} = 48\text{V}$, and $I_o = 0.5I_{o,max}$)

Characteristics	Symbols	Conditions	PT4832			Units	
			Min	Typ	Max		
Output Current	I_o	Each output	I_{o1} (5.0V) I_{o2} (3.3V) I_{o3} (2.5V)	0.25 (1) 0.1 (1) 0.1 (1)	— — —	5.0 (2) 5.5 (2) 5.5 (2)	A
		Total ($I_{o1} + I_{o2} + I_{o3}$)		—	—	9 (2)	A
Input Voltage Range	V_{in}	Continuous Surge (1 minute)		36 —	— —	75 80	V
Set-Point Voltage	V_o		V_{o1} V_{o2} V_{o3}	4.9 3.24 2.45	5.0 3.3 2.5	5.1 3.36 2.55	V
Temperature Variation	Reg_{temp}	$-40^\circ\text{C} \leq T_a \leq +85^\circ\text{C}$, $I_o = I_{o,min}$	V_{o1} V_{o2}/V_{o3}	— —	± 0.5 ± 0.5	— —	% V_o
Line Regulation	Reg_{line}	All outputs, Over V_{in} range		—	± 0.1	± 0.5	% V_o
Load Regulation	Reg_{load}	All outputs, $0 \leq I_o \leq I_{o,max}$		—	± 0.1	± 0.5	% V_o
Total Output Voltage Variation	$\Delta V_o, \text{tol}$	Includes set-point, line, load, $-40^\circ\text{C} \leq T_a \leq +85^\circ\text{C}$	V_{o1} V_{o2}/V_{o3}	— —	— —	± 3 (3) ± 3 (3)	% V_o
Efficiency	η	$I_{o1} = 5\text{A}$, $I_{o2} = 2\text{A}$, $I_{o3} = 2\text{A}$		—	86.7	—	%
V_o Ripple/Noise (0 to 20MHz bandwidth)	V_n		V_{o1} V_{o2} V_{o3}	— — —	30 25 25	— — —	mV _{pp}
Transient Response	t_{tr} V_{os}	0.1A/ μs load step, 50% to 75% $I_{o,max}$ V_o over/undershoot		— —	200 5	— —	μSec % V_o
Output Adjust Range	$V_{o,adj}$		$V_{o1}/V_{o2}/V_{o3}$	—	± 10	—	% V_o
Over-Current Threshold	I_{TRIP}	Total, all outputs. Reset with auto-recovery		—	11	—	A
Switching Frequency	f_s	Over V_{in} and I_o ranges		350	400	450	kHz
Under Voltage Lockout	V_{on} V_{off}	V_{in} increasing V_{in} decreasing		— —	35.5 34	— —	V
Turn-On Time	t_{on}	$V_{in} = 48\text{V}$ step		—	140 (4)	—	ms
Enable Control (pins 1 & 2) High-Level Input Voltage Low-Level Input Voltage Low-Level Input Current	V_{IH} V_{IL} I_{IL}	Referenced to $-V_{in}$ (pin 4)		4 -0.2	— —	15 (5) 0.8	V
Standby Input Current	$I_{in, standby}$	pins 1 & 2 open circuit		—	1	5	mA
Internal Input Capacitance	C_{int}			—	1.14	—	μF
External Output Capacitance	C_{o1} C_{o2} C_{o3}			0 0 0	220 220 220	1,000 (6) 1,000 (6) 1,000 (6)	μF
Primary/Secondary Isolation	V_{iso} C_{iso} R_{iso}			1500 — 10	— 2,200 —	— — —	V pF M Ω

- Notes:** (1) The converter will operate down to no load with reduced specifications.
(2) The sum-total current from outputs V_{o2} , and V_{o3} cannot exceed 9ADC.
(3) Limits are specified by design.
(4) Measured from the application of the input voltage to the instance that all outputs are in regulation.
(5) The Enable inputs (pins 1 & 2) have internal pull-ups. Leaving pin 1 open-circuit and connecting pin 2 to $-V_{in}$ allows the the converter to operate when input power is applied. The maximum open-circuit voltage is 4V.
(6) Ultra-low ESR capacitors, such as organic or polymer aluminum electrolytic types, may cause instability. Consult the factory before using.

PT4832 Performance Characteristics (See Notes A, B)

Efficiency vs Output Power
($I_{O1} = 5A, I_{O2} = 2A, I_{O3} = 2A$ represents 100% Load)

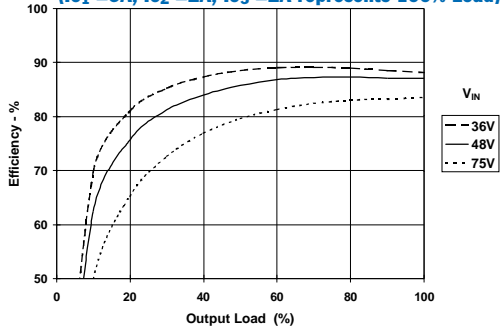

Efficiency vs Output Power
($I_{O1} = 2A, I_{O2} = 2A, I_{O3} = 5A$ represents 100% Load)

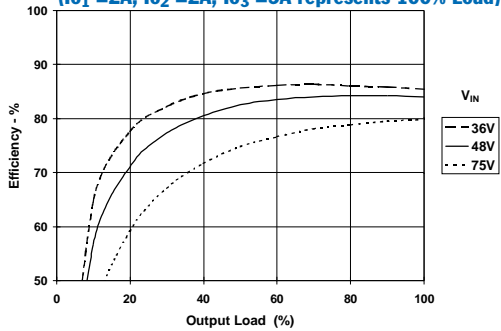

Output Ripple vs Output Power; $V_{in} = 48V$
($I_{O1} = 5A, I_{O2} = 2A, I_{O3} = 2A$ represents 100% Load)

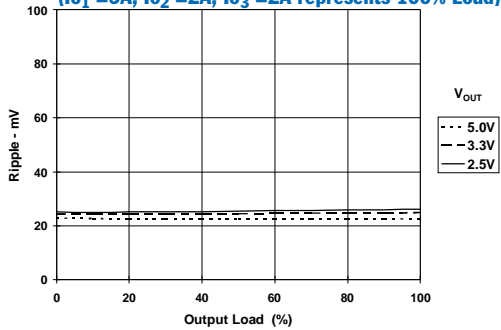

Output Ripple vs Output Power; $V_{in} = 48V$
($I_{O1} = 2A, I_{O2} = 2A, I_{O3} = 5A$ represents 100% Load)

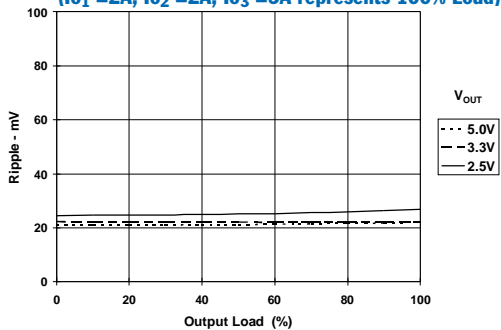

PT4832 Thermal Performance (See Note C)
($I_{O1} + I_{O2} + I_{O3} = 9A$, represents 100% Load)

Power Dissipation vs Output Power

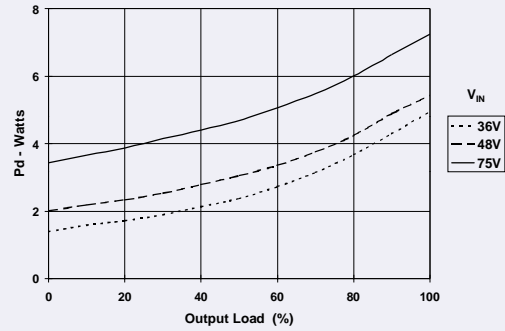

Safe Operating Area @ $V_{in} = 48V$

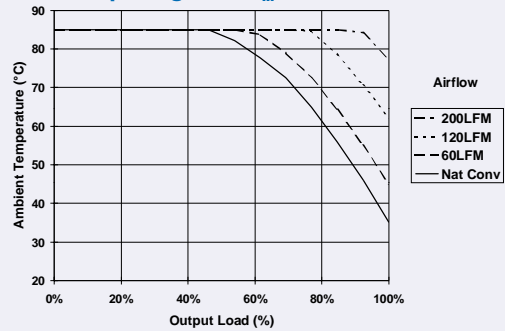

Note A: All Characteristic data in the above graphs has been developed from actual products tested at 25°C. This data is considered typical data for the ISR.
Note B: Output Load (%) represents the percent drawn from each output of the stated 100% load condition.
Note C: SOA curves represent operating conditions at which the internal components are at or below the manufacturer's maximum rated operating temperatures.

PT4833 Electrical Specifications (Unless otherwise stated, the operating conditions are: $T_a = 25^\circ\text{C}$, $V_{in} = 48\text{V}$, and $I_o = 0.5I_{o,max}$)

Characteristics	Symbols	Conditions	PT4833			Units	
			Min	Typ	Max		
Output Current	I_o	Each output	I_{o1} (3.3V)	0.25 (1)	—	8 (2)	A
			I_{o2} (2.0V)	0.1 (1)	—	6 (2)	
			I_{o3} (1.5V)	0.1 (1)	—	6 (2)	
		Total ($I_{o1} + I_{o2} + I_{o3}$)	—	—	12 (2)	A	
Input Voltage Range	V_{in}	Continuous Surge (1 minute)		36	—	75	V
				—	—	80	
Set-Point Voltage	V_o		V_{o1}	3.24	3.3	3.36	V
			V_{o2}	1.96	2.0	2.04	
			V_{o3}	1.47	1.5	1.53	
Temperature Variation	Reg_{temp}	$-40^\circ\text{C} \leq T_a \leq +85^\circ\text{C}$, $I_o = I_{o,min}$	V_{o1}	—	± 0.5	—	% V_o
			V_{o2}/V_{o3}	—	± 0.5	—	
Line Regulation	Reg_{line}	All outputs, Over V_{in} range		—	± 0.1	± 0.5	% V_o
Load Regulation	Reg_{load}	All outputs, $0 \leq I_o \leq I_{o,max}$		—	± 0.1	± 0.5	% V_o
Total Output Voltage Variation	$\Delta V_o, \text{tol}$	Includes set-point, line, load, $-40^\circ\text{C} \leq T_a \leq +85^\circ\text{C}$	V_{o1}	—	—	± 3 (3)	% V_o
			V_{o2}/V_{o3}	—	—	± 3 (3)	
Efficiency	η	$I_{o1} = 6\text{A}$, $I_{o2} = 2\text{A}$, $I_{o3} = 2\text{A}$		—	86	—	%
V_o Ripple/Noise (0 to 20MHz bandwidth)	V_n		V_{o1}	—	40	—	mV _{pp}
			V_{o2}	—	25	—	
			V_{o3}	—	25	—	
Transient Response	t_{tr} V_{os}	0.1A/ μs load step, 50% to 75% $I_{o,max}$ V_o over/undershoot		—	200	—	μSec % V_o
				—	3	—	
Output Adjust Range	$V_{o,adj}$		$V_{o1}/V_{o2}/V_{o3}$	—	± 10	—	% V_o
Over-Current Threshold	I_{TRIP}	Total, all outputs. Reset with auto-recovery		—	14	—	A
Switching Frequency	f_s	Over V_{in} and I_o ranges		350	400	450	kHz
Under Voltage Lockout	V_{on} V_{off}	V_{in} increasing V_{in} decreasing		—	35.5	—	V
				—	34	—	
Turn-On Time	t_{on}	$V_{in} = 48\text{V}$ step		—	140 (4)	—	ms
Enable Control (pins 1 & 2) High-Level Input Voltage Low-Level Input Voltage	V_{IH} V_{IL}	Referenced to $-V_{in}$ (pin 4)		4	—	15 (5)	V
				-0.2	—	0.8	
Low-Level Input Current	I_{IL}			—	1	2	mA
Standby Input Current	$I_{in, standby}$	pins 1 & 2 open circuit		—	1	5	mA
Internal Input Capacitance	C_{int}			—	1.14	—	μF
External Output Capacitance	C_{o1} C_{o2} C_{o3}			0	220	1,000 (6)	μF
				0	220	1,000 (6)	
				0	220	1,000 (6)	
Primary/Secondary Isolation	V_{iso} C_{iso} R_{iso}			1500	—	—	V pF M Ω
				—	2,200	—	
				10	—	—	

Notes: (1) The converter will operate down to no load with reduced specifications.

(2) The sum-total current from outputs V_{o1} , V_{o2} , and V_{o3} cannot exceed 12ADC.

(3) Limits are specified by design.

(4) Measured from the application of the input voltage to the instance that all outputs are in regulation.

(5) The Enable inputs (pins 1 & 2) have internal pull-ups. Leaving pin 1 open-circuit and connecting pin 2 to $-V_{in}$ allows the the converter to operate when input power is applied. The maximum open-circuit voltage is 4V.

(6) Ultra-low ESR capacitors, such as organic or polymer aluminum electrolytic types, may cause instability. Consult the factory before using.

PT4833 Performance Characteristics (See Note A, B)

Efficiency vs Output Power
($I_{O1} = 8A, I_{O2} = 2A, I_{O3} = 2A$ represents 100% Load)

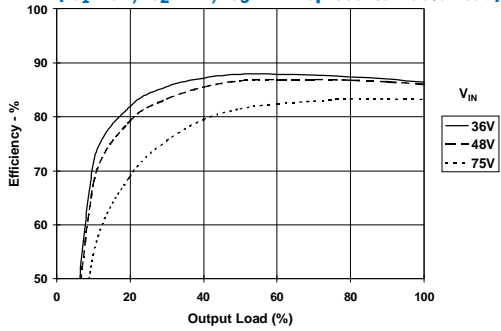

Efficiency vs Output Power
($I_{O1} = 4A, I_{O2} = 4A, I_{O3} = 4A$ represents 100% Load)

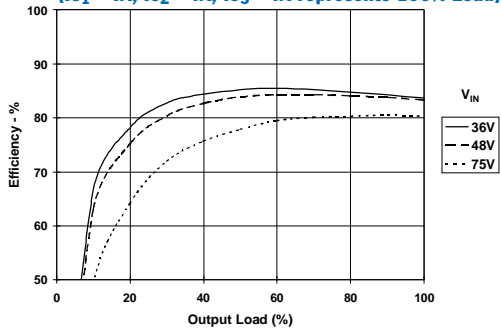

Output Ripple vs Output Power; $V_{in} = 48V$
($I_{O1} = 8A, I_{O2} = 2A, I_{O3} = 2A$ represents 100% Load)

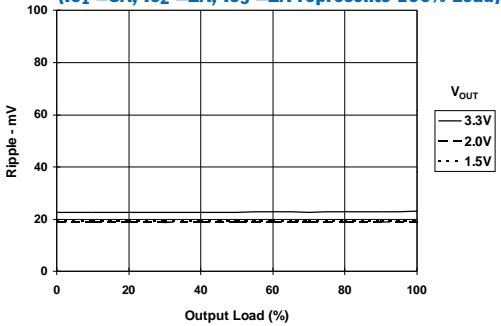

Output Ripple vs Output Power; $V_{in} = 48V$
($I_{O1} = 4A, I_{O2} = 4A, I_{O3} = 4A$ represents 100% Load)

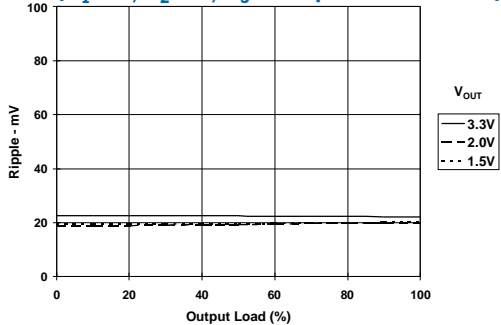

PT4833 Thermal Performance (See Note C)
($I_{O1} + I_{O2} + I_{O3} = 12A$, represents 100% Load)

Power Dissipation vs Output Load

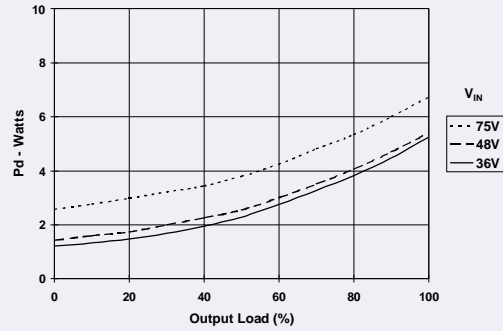

Safe Operating Area @ $V_{in} = 48V$

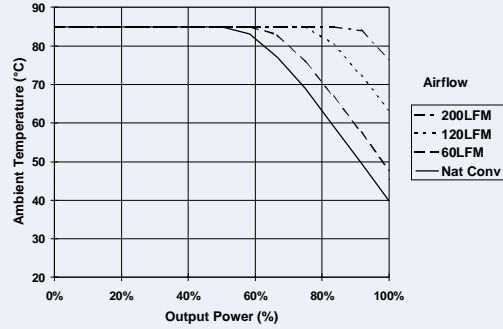

Note A: All Characteristic data in the above graphs has been developed from actual products tested at 25°C. This data is considered typical data for the ISR.
Note B: Output Load (%) represents the percent drawn from each output of the stated 100% load condition.
Note C: SOA curves represent operating conditions at which the internal components are at or below the manufacturer's maximum rated operating temperatures.

Operating Features of the PT4820 Triple-Output DC/DC Converters

Short-Circuit Protection

To protect against load faults the PT4820 series of triple-output DC/DC converters incorporate output short-circuit protection. When the combined output current from all three outputs exceeds the over-current threshold (see data sheet specifications), the PT4820 shuts down after a short period of typically 15ms. This forces the output voltage at all three regulated outputs to simultaneously fall to zero. Following shutdown, the module automatically attempts to recover by executing a soft-start power-up. This occurs at intervals of approximately 65ms. If the load fault persists, the module will continually cycle through successive over-current trips and restarts.

Over-Temperature Protection

The PT4820 DC/DC converter series have an internal temperature sensor, which monitors the temperature of the module's metal case. If the case temperature exceeds a nominal 110°C the converter will shut down. The converter will automatically restart when the sensed temperature returns to about 100°C.

Under-Voltage Lock-Out

The Under-Voltage Lock-Out (UVLO) circuit prevents operation of the converter whenever the input voltage to the module is insufficient to maintain output regulation. The UVLO has approximately 2V of hysteresis. This is to prevent oscillation with a slowly changing input voltage. Below the UVLO threshold the module is off and the enable control inputs, EN1 and EN2 are inoperative.

On/Off Output Voltage Sequencing

The power-up characteristic of the PT4820 series of DC/DC converters meets the requirements of microprocessor and DSP chipsets. All three outputs are internally sequenced to power-up in unison. Figure 1-1 shows the PT4820 output voltage rise times and characteristic shapes after either power is applied to the input of the converter, or the converter is enabled using one of the enable control inputs. All three output voltages rise simultaneously and monotonically until each reaches its respective output voltage. There is no turn-on overshoot and the output voltages are proportional to each other during power on.

Turn-On Time

The turn-on time varies with the input voltage. The typical turn-on time (measured from the application of a valid input voltage to instance all outputs are in regulation) is typically 140 milliseconds at $V_{in} = 48V$. The rise time of the output voltage is between 10 and 15 milliseconds.

Figure 1-1; V_{o1} , V_{o2} , V_{o3} Power-Up Sequence

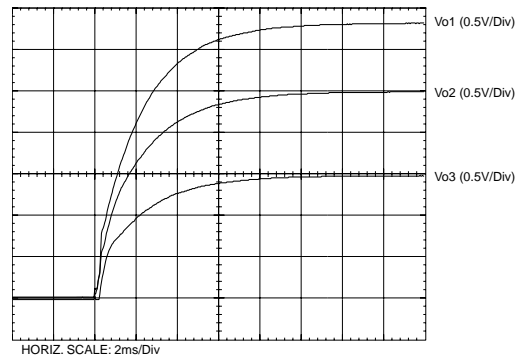

Primary-Secondary Isolation

The PT4820 series of DC/DC converters incorporate electrical isolation between the input terminals (primary) and the output terminals (secondary). All converters are production tested to a withstand voltage of 1500VDC. The isolation complies with UL60950 and EN60950, and the requirements for operational isolation. This allows the converter to be configured for either a positive or negative input voltage source.

The regulation control circuitry for these modules is located on the secondary (output) side of the isolation barrier. Control signals are passed between the primary and secondary sides of the converter. The data sheet 'Pin Descriptions' and 'Pin-Out Information' provides guidance as to which reference, primary or secondary, each pin is associated.

Input Current Limiting

The converter is not internally fused. For safety and overall system protection, the maximum input current to the converter must be limited. Active or passive current limiting can be used. Passive current limiting can be a fast acting fuse. A 125-V fuse, rated no more than 5A, is recommended. Active current limiting can be implemented with a current limited "Hot-Swap" controller.

Using the On/Off Enable Controls on the PT4820 Series of Triple Output DC/DC Converters

The PT4820 (48V input) series of triple-output DC/DC converters incorporate two output enable controls. EN1 (pin 1) is the *Positive Enable* input, and EN2 (pin 2) is the *Negative Enable* input. Both inputs are electrically referenced to $-V_{in}$ (pin 4) on the primary or input side of the converter. The *Enable* pins are ideally controlled with an open-collector (or open-drain) discrete transistor. A pull-up resistor is not required. If a pull-up resistor is added, the pull-up voltage must be limited to 15V.

Automatic (UVLO) Power-Up

Connecting EN2 (pin 2) to $-V_{in}$ (pin 4) and leaving EN1 (pin 1) open-circuit configures the converter for automatic power up. (See data sheet “Typical Application”). The converter control circuitry incorporates an “Under Voltage Lockout” (UVLO) function, which disables the converter until the minimum specified input voltage is present at $\pm V_{in}$. (See data sheet Specifications). The UVLO circuitry ensures a clean transition during power-up and power-down, allowing the converter to tolerate a slow-rising input voltage. For most applications EN1 and EN2, can be configured for automatic power-up.

Positive Output Enable (Negative Inhibit)

To configure the converter for a positive enable function, connect EN2 (pin 2) to $-V_{in}$ (pin 4), and apply the system On/Off control signal to EN1 (pin 1). In this configuration, applying less than 0.8V (with respect to $-V_{in}$ potential) to pin 1 disables the converter outputs. Figure 2-1 is an example of this implementation using a buffer transistor.

Figure 2-1; Positive Enable Configuration

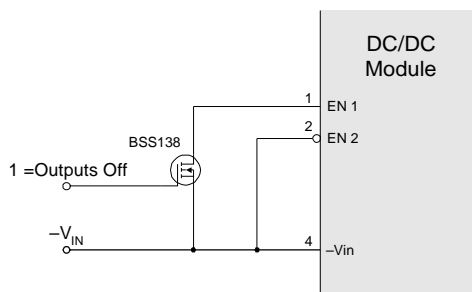

Negative Output Enable (Positive Inhibit)

To configure the converter for a negative enable function, EN1 (pin 1) is left open circuit, and the system On/Off control signal is applied to EN2 (pin 2). Applying less than 0.8V (with respect to $-V_{in}$ potential) to pin 2, enables the converter outputs. An example using a buffer transistor is again detailed in Figure 2-2. *Note: The converter will only produce and output voltage if a valid input voltage is applied to $\pm V_{in}$.*

Figure 2-2; Negative Enable Configuration

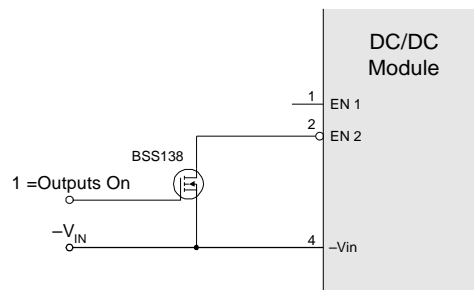

On/Off Enable Turn-On Time

When the On/Off enable inputs, EN1 or EN2 are used to enable the PT4820's output voltages, the turn-on delay time (measured from the transition of the enable signal to the instance the outputs begin to rise) will vary with the input voltage and the module's internal timing. At an input voltage of 48V, the total turn-on time is between 20 and 60 milliseconds. This turn-on time reduces as the input voltage is increased. The rise time of the output voltages is between 10 and 15 milliseconds.

Adjusting the Output Voltages of the PT4820 Triple-Output DC/DC Converters

The output voltages of the PT4820 series of triple-output DC/DC converters, V_{O1} , V_{O2} and V_{O3} are independently adjustable. The adjustment method uses a single external resistor, R_1 which may be used to adjust a selected output by up to a nominal $\pm 10\%$ from the factory preset value. The value of the resistor determines the magnitude of adjustment, and the placement of the resistor determines the direction of adjustment (up or down). Resistor values can be calculated using the appropriate formula (see below) and the constants provided in Table 3-2. Alternatively the value may be selected directly from Table 3-3. The placement of each resistor is detailed as follows.

Adjust Up: To increase a specific output, add a resistor R_1 between the appropriate V_{Ox} Adj (V_{O1} Adj, V_{O2} Adj, or V_{O3} Adj) and the output common (COM). See Figure 3-1(a) and Table 3-1 for the resistor placement and pin connections.

Figure 3-1a

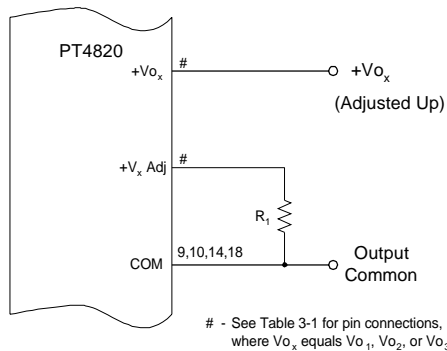

Adjust Down: Add a resistor (R_2), between the appropriate V_{Ox} Adj (V_{O1} , V_{O2} , or V_{O3}) and the output being adjusted. See Figure 3-1(b) and Table 1 for the resistor placement and pin connections.

Figure 3-1b

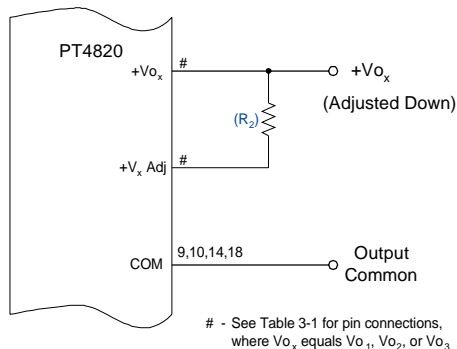

Table 3-1; Adjust Resistor Pin Connections

	To Adjust Up Connect R_1		To Adjust Down Connect (R_2)	
	from V_{Ox} Adj	to COM	from V_{Ox} Adj	to V_{Ox}
V_{O1}	11	10	11	12
V_{O2}	15	14	15	16
V_{O3}	19	18	19	20

Calculation of Adjust Values

The adjust resistor values may be calculated. Use the applicable formula and select the appropriate constants from Table 2 for the output and model being adjusted.

$$R_1 \text{ [Adjust Up]}^3 = \frac{R_o \cdot V_r}{V_a - V_o} - R_s \quad \text{k}\Omega$$

$$(R_2) \text{ [Adjust Down]}^3 = \frac{R_o (V_a - V_r)}{V_o - V_a} - R_s \quad \text{k}\Omega$$

Where: V_o = Original output voltage
 V_a = Adjusted output voltage
 V_r = The reference voltage from Table 3-2
 R_o = The resistance value in Table 3-2
 R_s = The series resistance from Table 3-2

Notes:

1. Use only a single 1% (or better) tolerance resistor in either the R_1 or (R_2) location to adjust a specific output. Place the resistor as close to the ISR as possible.
2. Never connect capacitors to any of the 'Vo_x Adj' pins. Any capacitance added to these control pins will affect the stability of the respective regulated output.
3. Adjustments made to any output must also comply with the following limitations.

$$V_{O1} \geq (V_{O2} + 0.5V), \text{ and}$$

$$V_{O1} \geq (V_{O3} + 0.5V)$$

PT4820 Series

Table 3-2

V_{O1}, V_{O2}, & V_{O3} OUTPUT VOLTAGE ADJUSTMENT RANGE AND FORMULA PARAMETERS

V_O (nom)	5.0V	3.3V	2.5V	2.0V	1.8V	1.5V	1.2V
V_a (min)	4.5V	2.97V	2.25V	1.8V	1.62V	1.35V	1.08V
V_a (max)	5.5V	3.63V	2.75V	2.2V	1.98V	1.65V	1.32V
V_r	1.225V	1.225V	1.225V	1.225	1.225V	1.225V	1.003V
R_O (kΩ)	15.4	11.0	10.2	10.2	12.1	7.5	9.76
R_S (kΩ)	33.2	40.2	40.2	24.9	22.1	5.36	3.65

Table 3-3

V_{O1}, V_{O2}, & V_{O3} OUTPUT VOLTAGE ADJUST RESISTOR VALUES (See Note 3 for adjustment limitations)

V_O (nom)	5.0V	3.3V	2.5	V_O (nom)	2.0V	1.8V	1.5V	1.2V
V_a (req'd)				V_a (req'd)				
2.25			(1.6)kΩ	1.080				(2.6)kΩ
2.3			(14.6)kΩ	1.100				(5.8)kΩ
2.35			(36.3)kΩ	1.120				(10.6)kΩ
2.4			(79.6)kΩ	1.140				(18.6)kΩ
2.45			(210.0)kΩ	1.160				(34.7)kΩ
2.5				1.180				(82.7)kΩ
2.55			210.0kΩ	1.200				
2.6			84.7kΩ	1.220				486.0kΩ
2.65			43.1kΩ	1.240				241.0kΩ
2.7			22.3kΩ	1.260				160.0kΩ
2.75			9.8kΩ	1.280				119.0kΩ
2.97		(18.0)kΩ		1.300				94.2kΩ
3.0		(24.9)kΩ		1.320				77.9kΩ
3.05		(40.1)kΩ		1.350			(0.9)kΩ	
3.1		(62.9)kΩ		1.375			(3.6)kΩ	
3.15		(101.0)kΩ		1.400			(7.8)kΩ	
3.2		(177.0)kΩ		1.425			(14.6)kΩ	
3.25		(405.0)kΩ		1.450			(28.4)kΩ	
3.3				1.475			(69.6)kΩ	
3.35		229.0kΩ		1.500				
3.4		94.5kΩ		1.525			362.0kΩ	
3.45		49.6kΩ		1.550			178.0kΩ	
3.5		27.2kΩ		1.575			117.0kΩ	
3.55		13.7kΩ		1.600			86.5kΩ	
3.6		4.7kΩ		1.620		(4.5)kΩ	71.2kΩ	
3.63		0.6kΩ		1.650		(12.2)kΩ	55.9kΩ	
•				1.700		(35.4)kΩ		
4.5	(67.7)kΩ			1.750		(105.0)kΩ		
4.6	(96.7)kΩ			1.800	(4.4)kΩ			
4.7	(145.0)kΩ			1.850	(17.6)kΩ	274.0kΩ		
4.8	(242.0)kΩ			1.900	(43.9)kΩ	126.0kΩ		
4.9	(533.0)kΩ			1.950	(123.0)kΩ	76.7kΩ		
5.0				2.000				
5.1	155.0kΩ			2.050	225.0kΩ			
5.2	61.1kΩ			2.100	100.0kΩ			
5.3	29.7kΩ			2.150	58.4kΩ			
5.4	14.0kΩ			2.200	37.6kΩ			
5.5	4.5kΩ							

R1 = (Blue) R2 = Black

VDE Approved Installation Instructions (Installationsanleitung)

Nennspannung (Rated Voltage):	PT4820 36 to 72 Vdc, Transient to 80Vdc
Nennaufnahme (Rated Input):	PT4820 1.5 Adc
Nennleistung (Rated Power):	40 Watts Maximum
Ausgangsspannung (Sec. Voltage):	<u>PT4820 Series</u> PT4821, +3.3/ +2.5/ +1.5 Vdc; 8.0/ 6.0/ 6.0 Adc; Max total is 12Adc PT4822, +3.3/ +1.8/ +1.5 Vdc; 8.0/ 6.0/ 6.0 Adc; Max total is 12Adc PT4823, +3.3/ +2.5/ +1.2 Vdc; 8.0/ 6.0/ 6.0 Adc; Max total is 12Adc PT4824, +3.3/ +1.8/ +1.2 Vdc; 8.0/ 6.0/ 6.0 Adc; Max total is 12Adc PT4825, +3.3/ +1.5/ +1.2 Vdc; 8.0/ 6.0/ 6.0 Adc; Max total is 12Adc PT4826, +5.0/ +3.3/ +1.8 Vdc; 5.0/ 5.5 /5.5 Adc; Max total is 9Adc PT4827, +3.3/ +2.5/ +1.8 Vdc; 8.0/ 6.0 /6.0 Adc; Max total is 12Adc PT4828, +5.0/ +2.5/ +1.5 Vdc; 5.0/ 5.5 /5.5 Adc; Max total is 9Adc PT4829, +5.0/ +1.8/ +1.5 Vdc; 5.0/ 5.5 /5.5 Adc; Max total is 9Adc PT4831, +5.0/ +3.3/ +1.5 Vdc; 5.0/ 5.5 /5.5 Adc; Max total is 9Adc PT4832, +5.0/ +3.3/ +2.5 Vdc; 5.0/ 5.5 /5.5 Adc; Max total is 9Adc
Ausgangsstrom (Sec. Current): oder (or)	
Ausgangsleistung (Sec. Power):	

Angabe der Umgebungstemperatur

(Information on ambient temperature): +85 °C maximum as tested

Besondere Hinweise (Special Instructions):

Es ist vorzusehen, daß die Spannungsversorgung in einer Endanwendung über eine isolierte Sekundärschaltung bereit gestellt wird. Die Eingangsspannung der Spannungsversorgungsmodule muss eine verstärkte Isolierung von der Wechselstromquelle aufweisen.

Die Spannungsversorgung muss gemaess den Gehaeuse-, Montage-, Kriech- und Luftstrecken-, Markierungs- und Trennanforderungen der Endanwendung installiert werden.

(The power supply is intended to be supplied by isolated secondary circuitry in an end use application. The input power to these power supplies shall have reinforced insulation from the AC mains.

The power supply shall be installed in compliance with the enclosure, mounting, creepage, clearance, casualty, markings, and segregation requirements of the end-use application.

Offenbach,

VDE Prüf- und Zertifizierungsinstitut
Abteilung / Department TD

(Jürgen Bärwinkel)

Ort / Place: Datum / Date: Nov 6, 2002

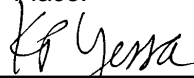

(Stempel und Unterschrift des Herstellers / Stamp and signature of the manufacturer)

IMPORTANT NOTICE

Texas Instruments Incorporated and its subsidiaries (TI) reserve the right to make corrections, modifications, enhancements, improvements, and other changes to its products and services at any time and to discontinue any product or service without notice. Customers should obtain the latest relevant information before placing orders and should verify that such information is current and complete. All products are sold subject to TI's terms and conditions of sale supplied at the time of order acknowledgment.

TI warrants performance of its hardware products to the specifications applicable at the time of sale in accordance with TI's standard warranty. Testing and other quality control techniques are used to the extent TI deems necessary to support this warranty. Except where mandated by government requirements, testing of all parameters of each product is not necessarily performed.

TI assumes no liability for applications assistance or customer product design. Customers are responsible for their products and applications using TI components. To minimize the risks associated with customer products and applications, customers should provide adequate design and operating safeguards.

TI does not warrant or represent that any license, either express or implied, is granted under any TI patent right, copyright, mask work right, or other TI intellectual property right relating to any combination, machine, or process in which TI products or services are used. Information published by TI regarding third-party products or services does not constitute a license from TI to use such products or services or a warranty or endorsement thereof. Use of such information may require a license from a third party under the patents or other intellectual property of the third party, or a license from TI under the patents or other intellectual property of TI.

Reproduction of information in TI data books or data sheets is permissible only if reproduction is without alteration and is accompanied by all associated warranties, conditions, limitations, and notices. Reproduction of this information with alteration is an unfair and deceptive business practice. TI is not responsible or liable for such altered documentation.

Resale of TI products or services with statements different from or beyond the parameters stated by TI for that product or service voids all express and any implied warranties for the associated TI product or service and is an unfair and deceptive business practice. TI is not responsible or liable for any such statements.

Mailing Address:

Texas Instruments
Post Office Box 655303
Dallas, Texas 75265